

DRONE ARENA

User Guide

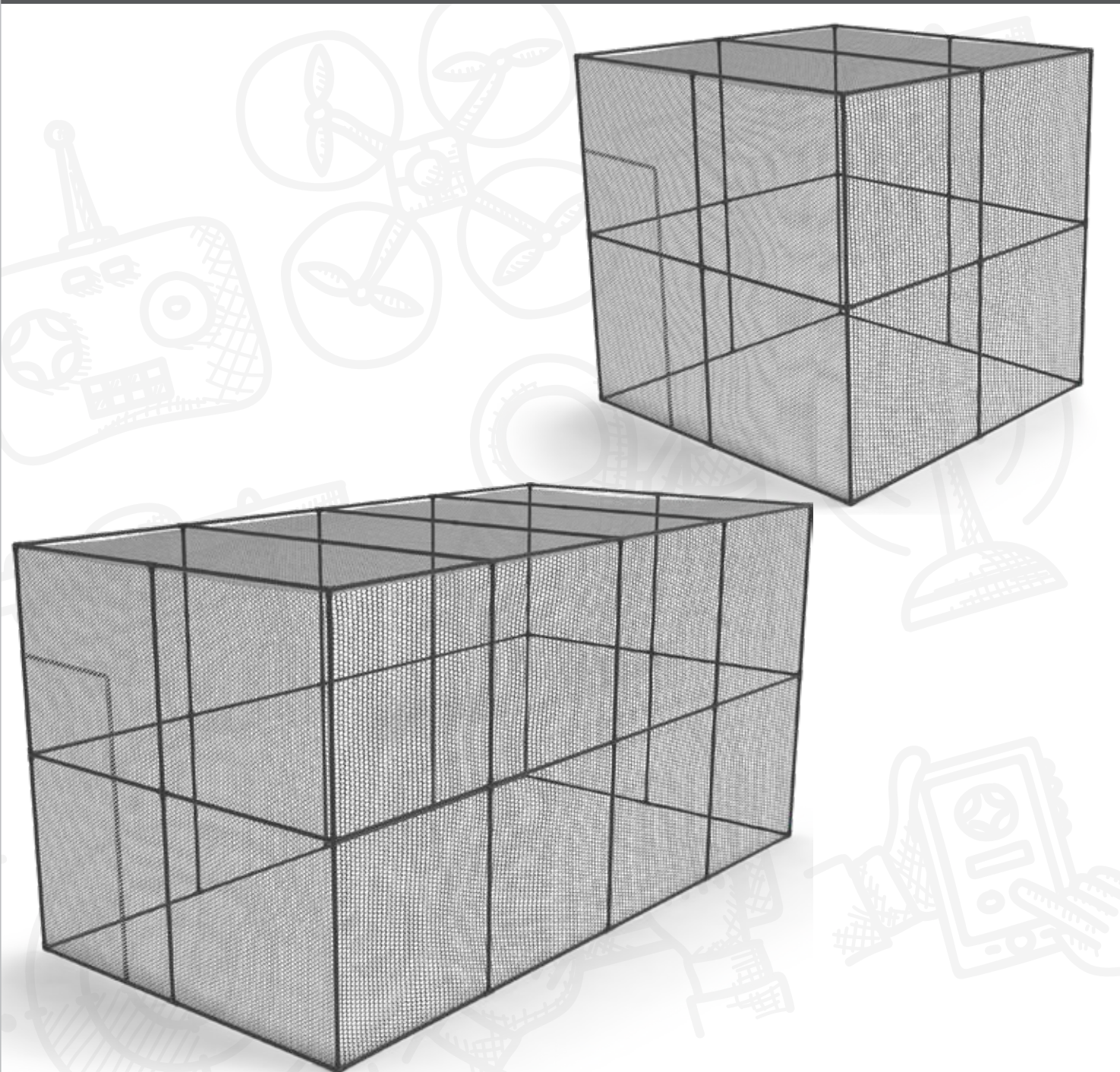

Written by Terry Carter.

Content advising by Paul Uttley, Katlie Brynds, Pamela Scifers, and Tim Lankford.

Desktop publishing and photography by Todd McGeorge.

©2020 Pitsco, Inc., 915 E. Jefferson, Pittsburg, KS 66762

All rights reserved. This product and related documentation are protected by copyright and are distributed under licenses restricting their use, copying, and distribution. No part of this product or related documentation may be reproduced in any form by any means without prior written authorization of Pitsco, Inc.

All other product names mentioned herein might be the trademarks of their respective owners.

V1.0
01/20
45980

Cautionary and Warning Statements

- This product is intended for indoor use.
- Adult supervision is required while drones are operated inside the arena.
- While drones are in operation, students should not be inside the arena; students should stay at least three feet away from the arena.
- Do not allow students to hang or climb on netting.
- Do not hang heavy objects from the structural members of the arena or from the net.
- Students should enter and exit through only the netted door of the arena.

Disclaimer

Pitsco, Inc. is not responsible for bodily injury or property damage that results from misuse of its products. Follow all directions and standard safety procedures to ensure student safety.

Warranty

Pitsco provides a one-year limited warranty against defects in manufacturing on all items purchased. In a warranty situation, Pitsco will arrange for the return of defective items for evaluation. Qualified Pitsco staff will determine warranty coverage and notify the customer. Items under warranty will be repaired or replaced at Pitsco's discretion. Customers will be billed for all costs associated with non-warranty items.

Overview

The Pitsco Drone Arena is a portable indoor solution for testing, training, and competing with drone technologies. It can be assembled quickly and easily with the use of a 6' to 10' step ladder. Although the arena was designed with drones in mind, feel free to incorporate other elements such as robotics in competition designs. It is possible for one person to assemble the arena, but it is recommended that two or more people assemble it.

Components of the 10' x 10' x 10' Arena

- 44 pipes (1" x 5')
- 8 three-way elbow connectors
- 4 cross connectors
- 10 T connectors
- 6 four-way corner connectors
- 3 couplers
- Netting (10' x 10' x 10')
- 50 bungee cord ties (4")

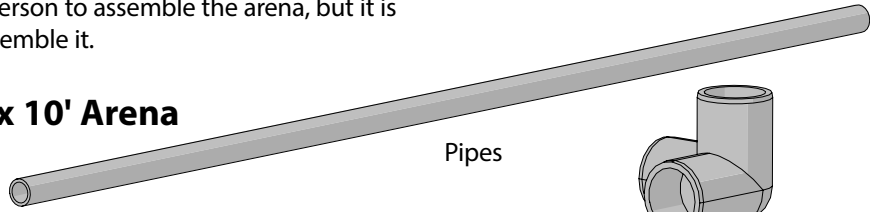

Pipes

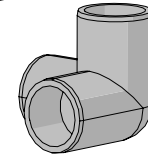

Three-way elbow connectors

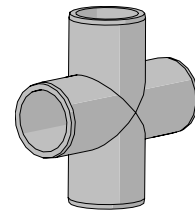

Cross connectors

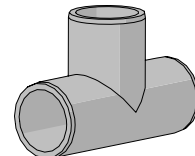

T connectors

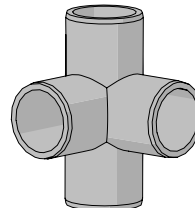

Four-way corner connectors

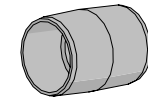

Couplers

Components of the 10' x 10' x 20' Arena

- 66 pipes (1" x 5')
- 8 three-way elbow connectors
- 8 cross connectors
- 10 T connectors
- 12 four-way corner connectors
- 3 couplers
- Netting (10' x 10' x 20')
- 100 bungee cord ties (4")

Note: In each arena kit, some extra pieces are included. Save them in case you need them for future use.

Additional bungee cord ties can be used to attach curriculum field elements to the arena.

Items Needed (not included)

- Stepladder (6' to 10', depending on height of installer)

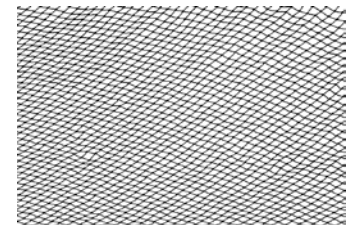

Netting

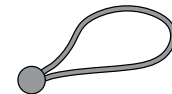

Bungee cord ties

Setup Instructions (10' x 10' x 10')

1. Lay out pipes to form a square base. Each side is made up of two pipes. Connect the corners using four three-way elbow connectors and connect each side using four T connectors.

Note: Each connector should have a receptacle facing up.

Most pieces will fit snugly together. If a connection is loose, a small piece of tape can be added to the end of a pipe to tighten the fit.

- Components needed:
 - 4 three-way elbow connectors
 - 4 T connectors
 - 8 pipes

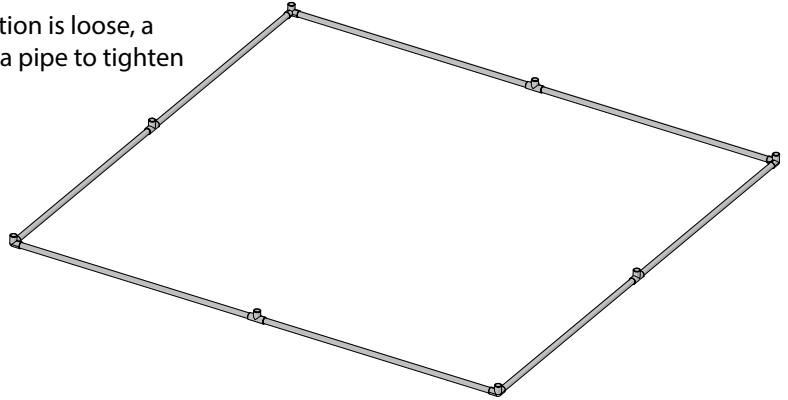

2. Place eight pipes firmly into the receptacles of the connectors on the base.

- Components needed:
 - 8 pipes

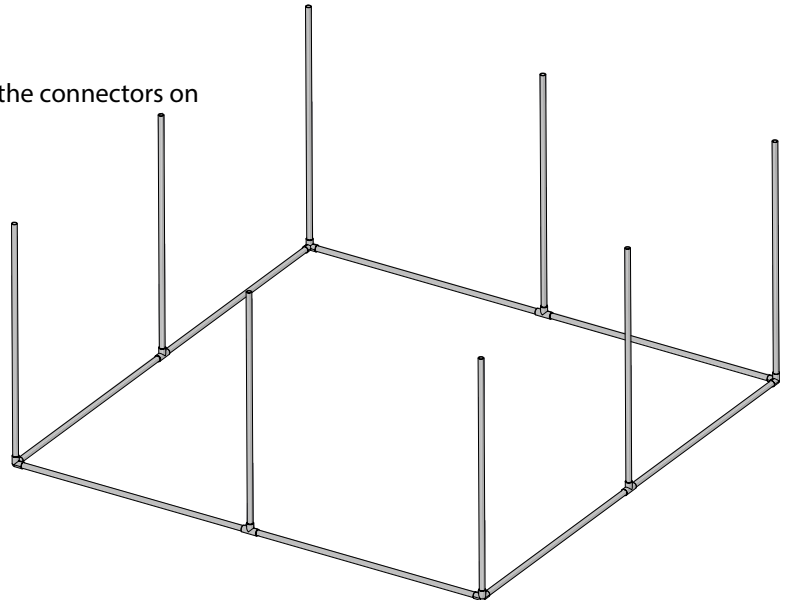

3. Construct a square middle band using two pipes for each side. Connect sections of the frame by using four-way corner connectors in the corners and cross connectors in the sides. **Note:** Each connector should have a receptacle facing up.

- Components needed:
 - 4 four-way corner connectors
 - 4 cross connectors
 - 8 pipes

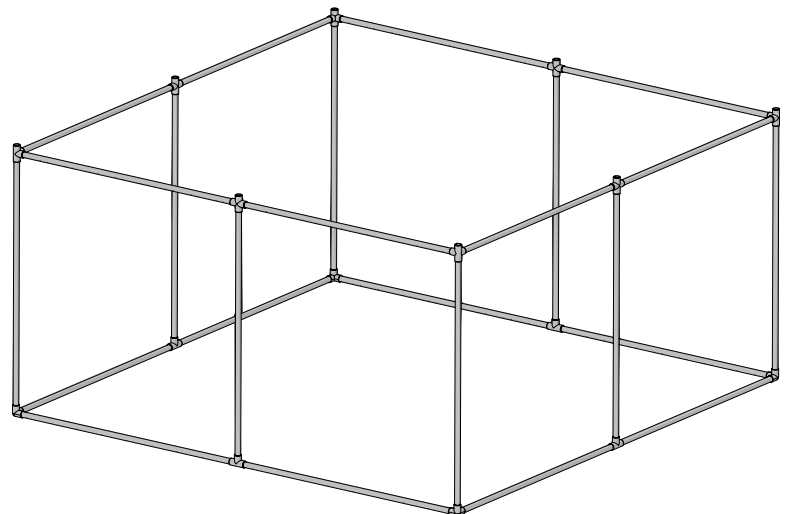

4. Place eight pipes firmly into the receptacles of the connectors on the middle band.

- Components needed:
 - 8 pipes

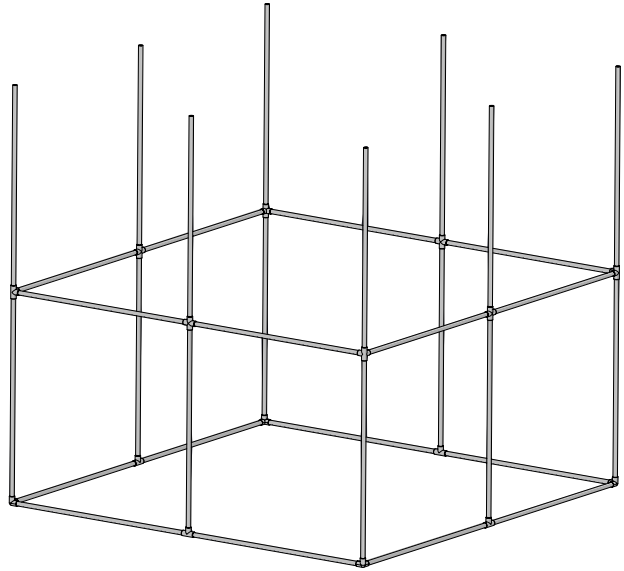

5. Using a ladder, connect the pipes to make the square top band. Firmly attach the corners using three-way elbow connectors. Connect the pipes of two opposite sides using T connectors. Connect the pipes of the other two opposite sides using four-way corner connectors.

- Components needed:
 - 4 three-way elbow connectors
 - 2 T connectors
 - 4 four-way corner connectors
 - 8 pipes

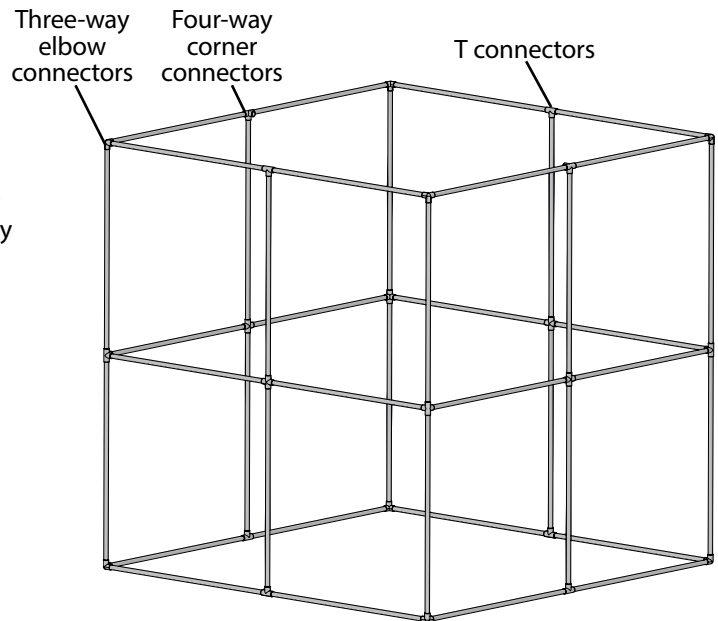

6. Use two pipes and a coupler to create a brace between the two four-way corner connectors on the top section. **Note:** The frame might feel a little wobbly at this point. It will become more stable after the netting is added and tension is increased.

- Components needed:
 - 2 pipes
 - 1 coupler

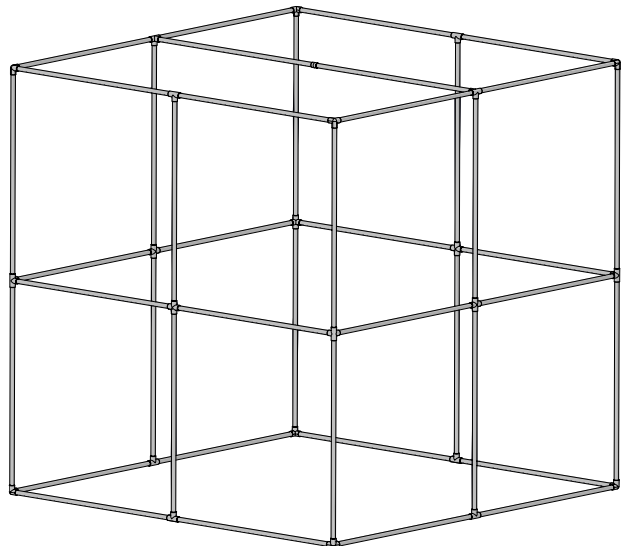

- Take the netting out of the box and place it inside the frame structure. The four corners of the netting are tied together. There is a tag that indicates the location of the door. Orient the netting so the door is on the side you want. Remove the tie and take the four corners to their respective areas of the arena.



- Use a ladder to attach each of the four net corners to the frame with with two bungee cord ties as shown in the image. Starting at the top of the arena, use bungee cord ties to attach the netting to the frame at the positions indicated in red. As you attach the netting, you should notice the frame becoming more stable from the tension and weight of the netting.

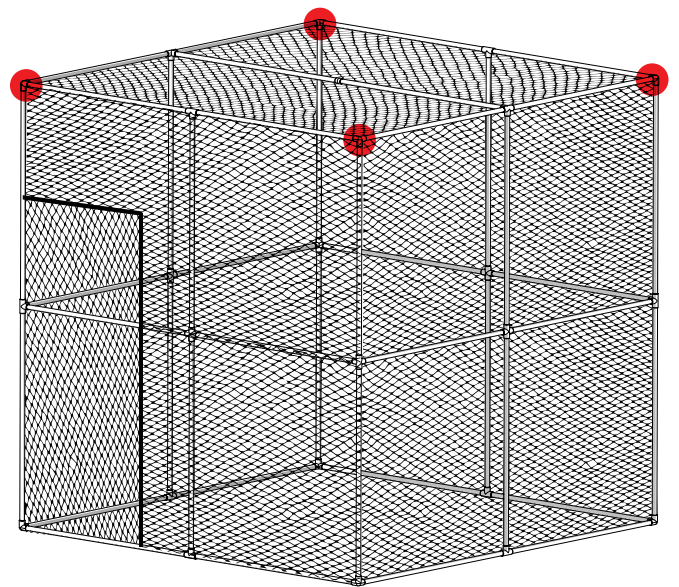

- Use additional bungee cord ties to secure the netting to the frame using one bungee cord tie at each location. Suggested locations for bungee cord ties are shown in red. You can use fewer or more as needed.

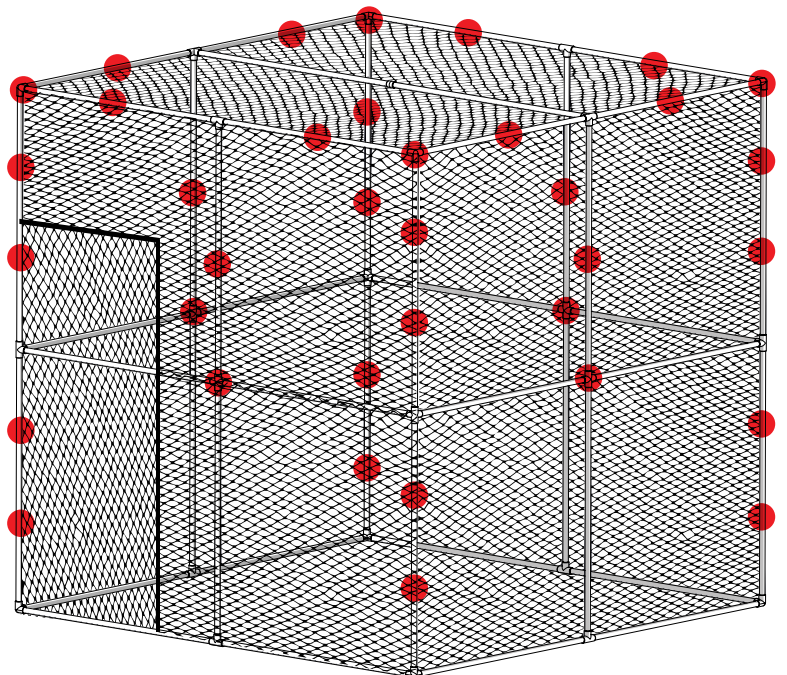

Tear-Down Instructions

1. When ready to disassemble the arena, it is recommended to reverse the setup process. After the arena is totally empty, remove the bungee cord ties from the netting. Start with the lower cords and progress to the upper levels, leaving the top four corners attached.
2. Remove the bungee cord ties from the top four corners. Bring the four corner pieces to the center of the netting and use one bungee cord tie to tie them together.
3. Fold the netting and place back in the box.
4. Using a ladder, start at the top and take all the pipes and connectors apart and place them back in their boxes. **Note:** If some connections have become too tight to remove by hand, use a rubber mallet to tap them apart. Do not use any tools with hard surfaces as this might damage or break your framing pieces.

Setup Instructions (10' x 10' x 20')

1. Lay out pipes to form a rectangular base. Each long side is made up of four pipes. Each short side is made up of two pipes. Connect the corners using four three-way elbow connectors and connect each side pipe using eight T connectors. **Note:** Each connector should have a receptacle facing up.

Most pieces will fit snugly together. If a connection is loose, a small piece of tape can be added to the end of a pipe to tighten the fit.

- Components needed:
 - 4 three-way elbow connectors
 - 8 T connectors
 - 12 pipes

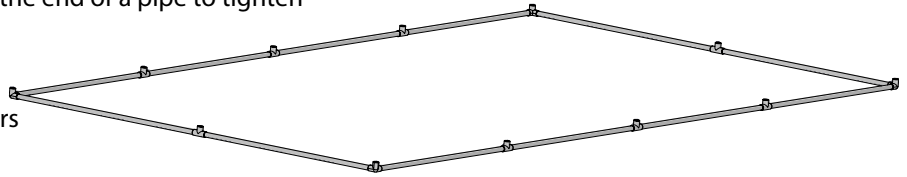

2. Place 12 pipes firmly into the receptacles of the connectors on the base.

- Components needed:
 - 12 pipes

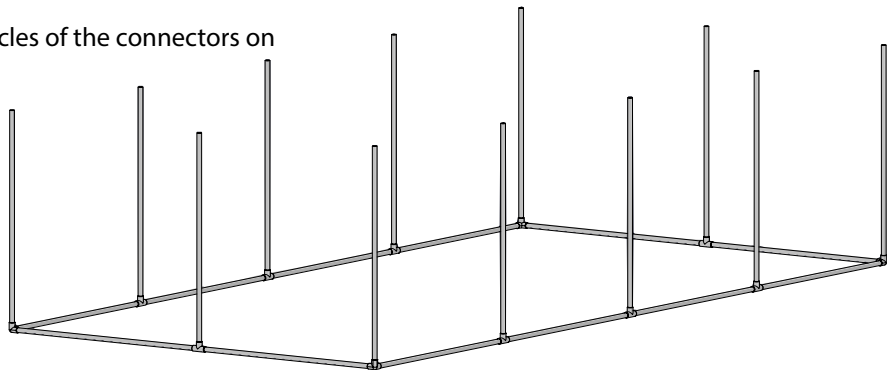

3. Construct a rectangular middle band using four pipes for each long side and two pipes for each short side. Connect sections of the frame by using four-way corner connectors in the corners and cross connectors in the sides. **Note:** Each connector should have a receptacle facing up.

- Components needed:
 - 4 four-way corner connectors
 - 8 cross connectors
 - 12 pipes

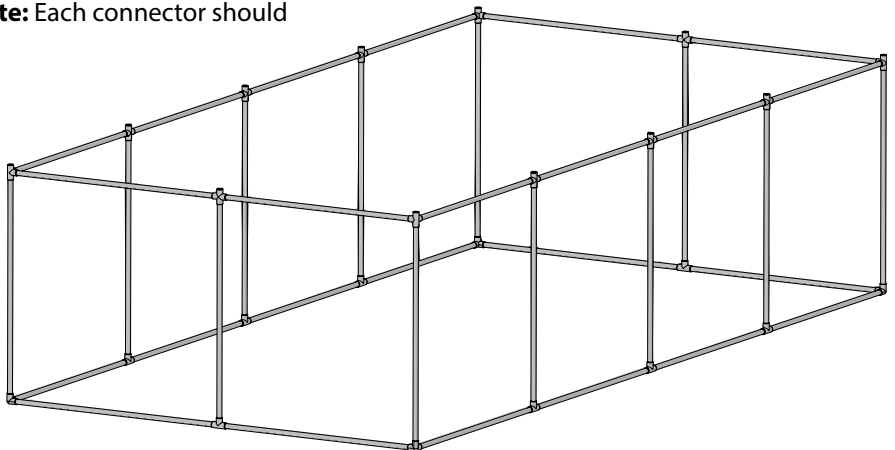

4. Place 12 pipes firmly into the receptacles of the connectors on the middle band.

- Components needed:
 - 12 pipes

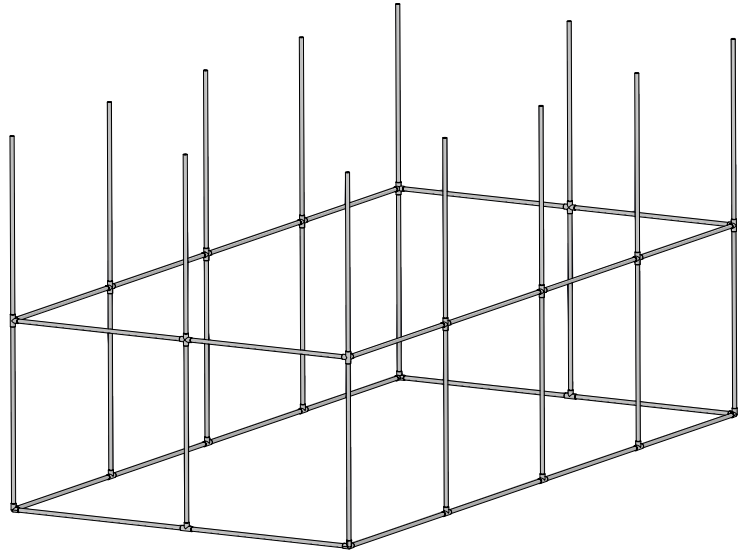

5. Using a ladder, connect the pipes to make the rectangular top band. Firmly attach the corners using three-way elbow connectors. Connect the pipes on each short side using T connectors. Connect the pipes on each long side by using four-way corner connectors.

- Components needed:
 - 6 four-way corner connectors
 - 4 three-way elbow connectors
 - 2 T connectors
 - 12 pipes

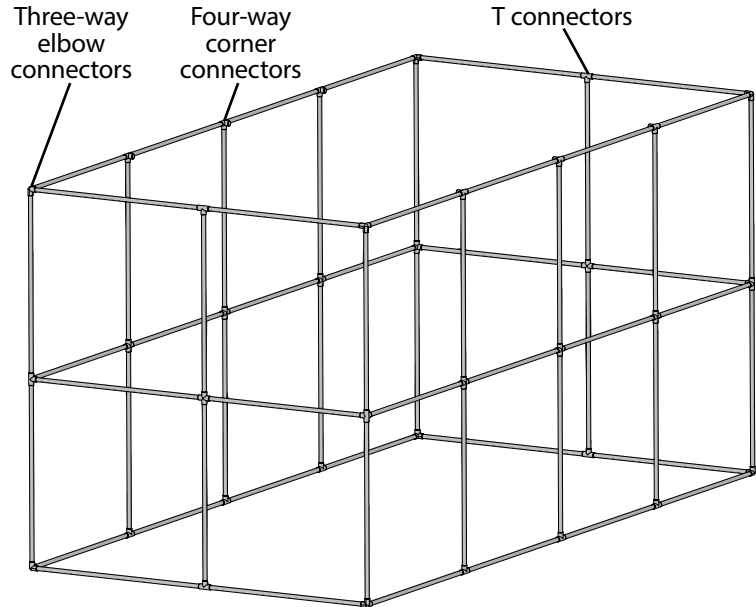

6. Use six pipes and three couplers to create braces between the six four-way elbow connectors on the top section. **Note:** The frame might feel a little wobbly at this point. It will become more stable after the netting is added and tension is created.

- Components needed:
 - 6 pipes
 - 3 couplers

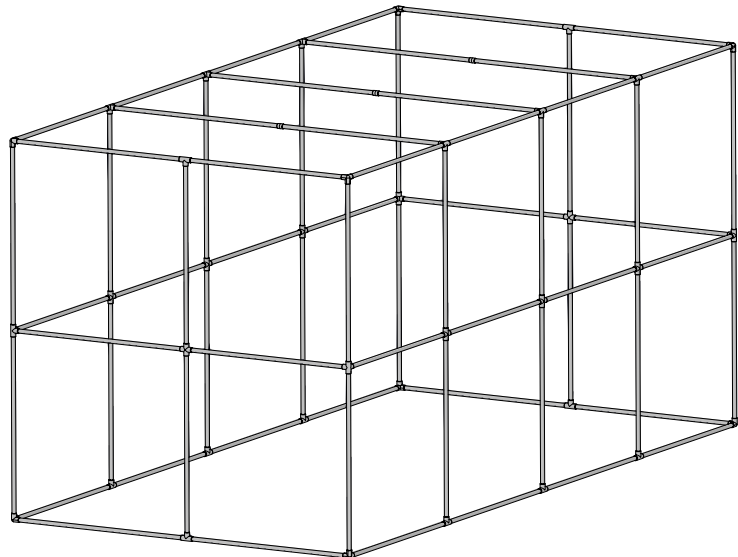

7. Take the netting out of the box and place it inside the frame structure. The four corners of the netting are tied together. There is a tag that indicates the location of the door. Orient the netting so the door is on the short side you want. Remove the tie and take the four corners to their respective areas of the arena.



8. Use a ladder to attach each of the two corners at one of the short ends to the frame with two bungee cord ties as shown in the image. Use one bungee cord tie to attach the netting to the frame, starting from the two corners of the arena, and progress down the frame at the positions indicated in red until you attach the opposite two corners using two bungee cord ties. As you attach the netting, you should notice the frame becoming more stable from the tension and weight of the netting.

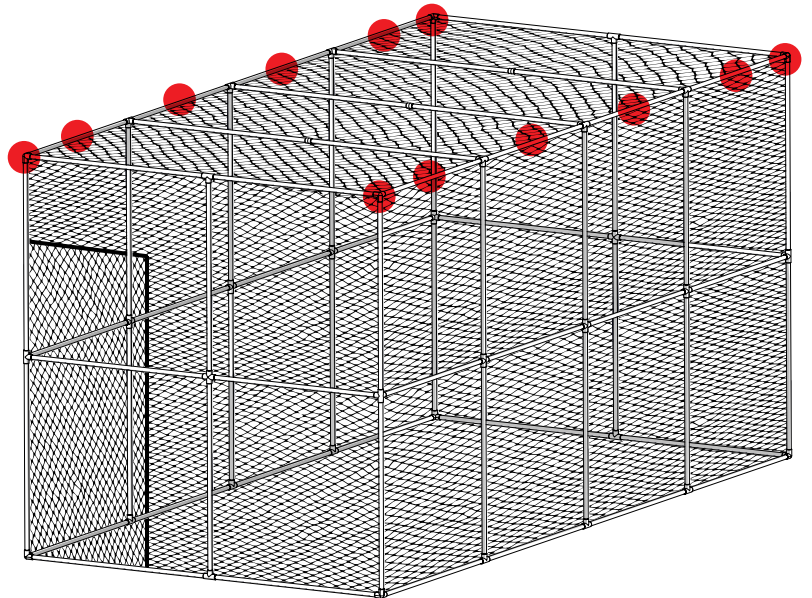

9. Use additional bungee cord ties to secure the netting to the frame using one bungee cord tie at each location. Suggested locations for bungee cord ties are shown in red. You can use fewer or more as needed.

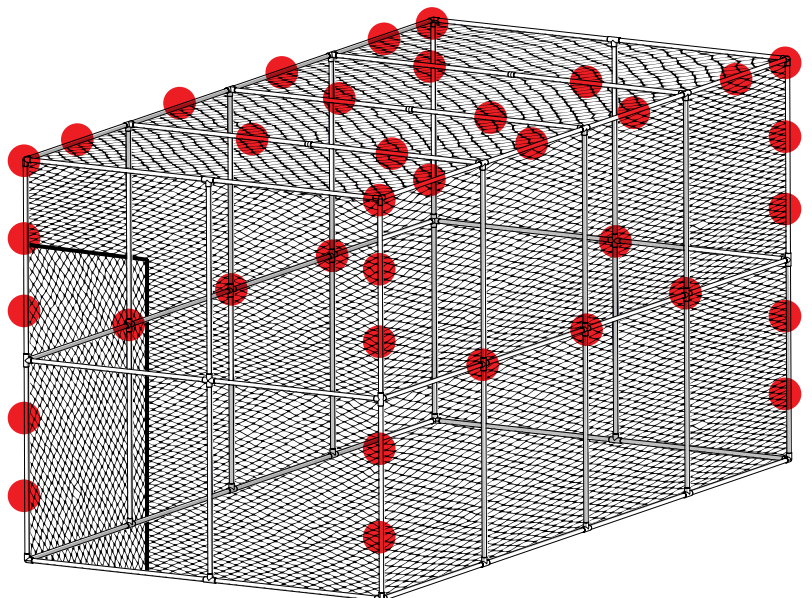

Tear-Down Instructions

1. When ready to disassemble the arena, it is recommended to reverse the setup process. After the arena is totally empty, remove the bungee cord ties from the netting. Start with the lower cords and progress to the upper levels, leaving the top four corners and sides attached.
2. Remove the bungee cord ties from two short corners and proceed to remove remaining cords to the other end. Bring the four corner pieces to the center of the netting and use one bungee cord tie to tie them together.
3. Fold the netting and place back in box.
4. Using a ladder, start at the top and take all the pipes and connectors apart and place them back in their boxes. **Note:** If some connections have become too tight to remove by hand, use a rubber mallet to tap them apart. Do not use any tools with hard surfaces as this might damage or break your framing pieces.

DRONE ARENA

User Guide

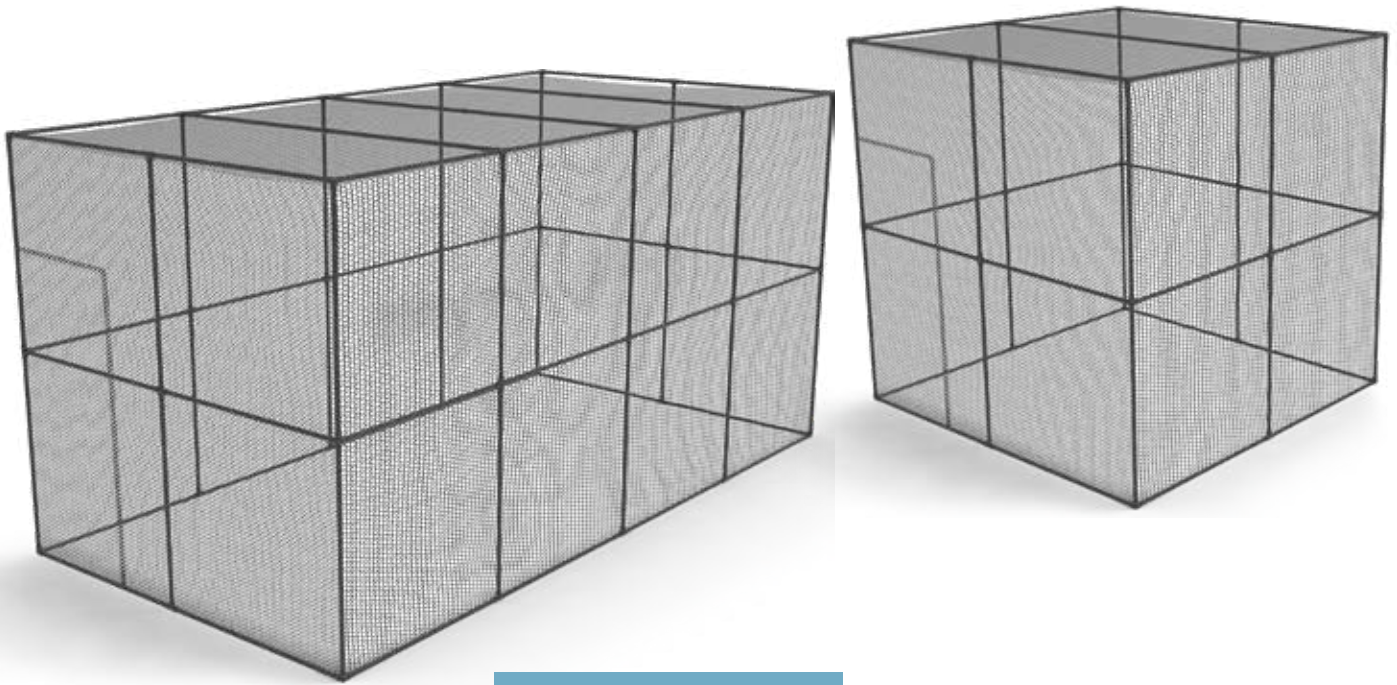

HAVE QUESTIONS?

There are a variety of ways
to get in touch with us:

Call us at [800-358-4983](tel:800-358-4983).

Email us at orders@pitsco.com.

Chat with us on Pitsco.com/support.

