

1

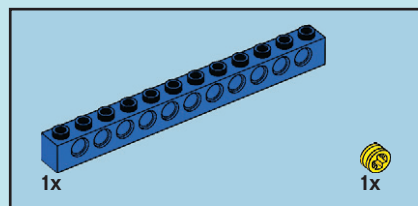

2

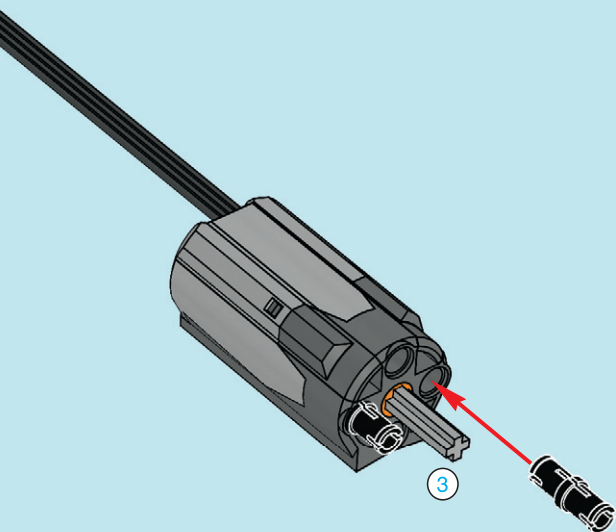

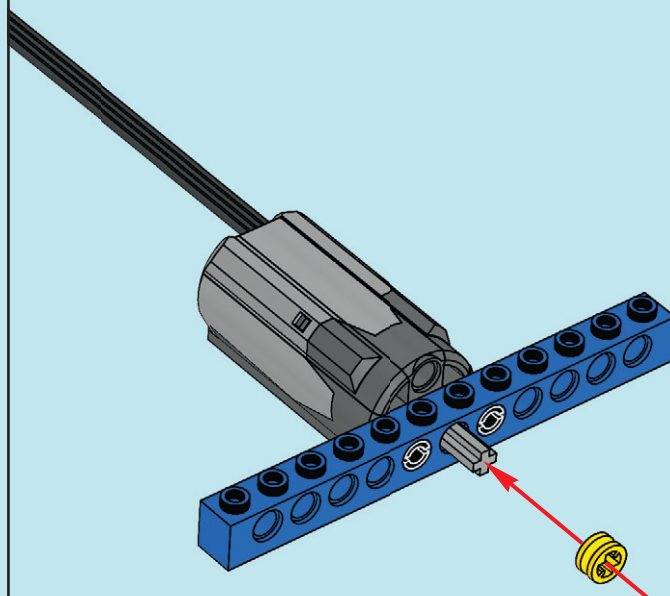
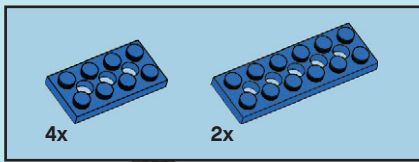

3

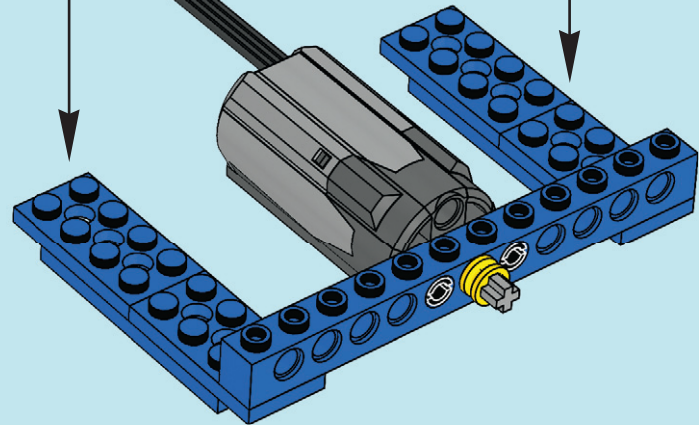
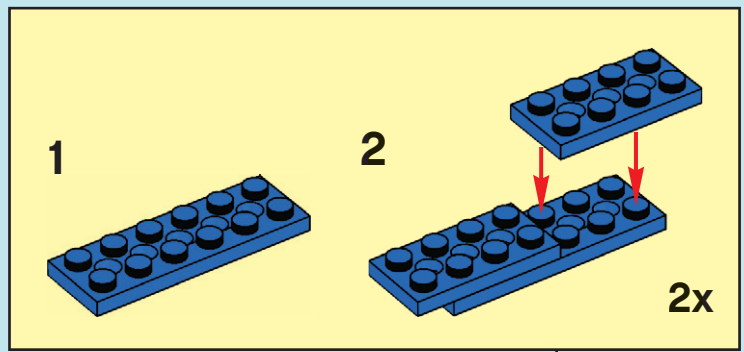

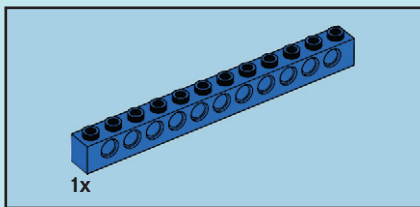

4

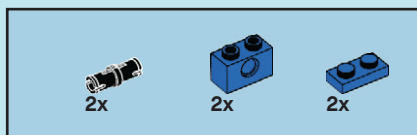
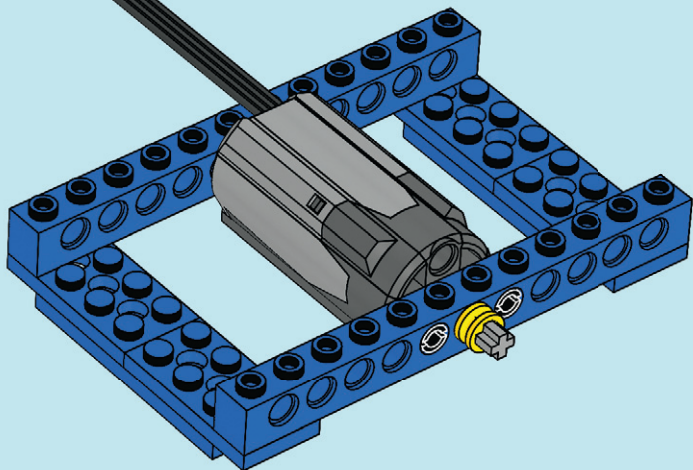

5

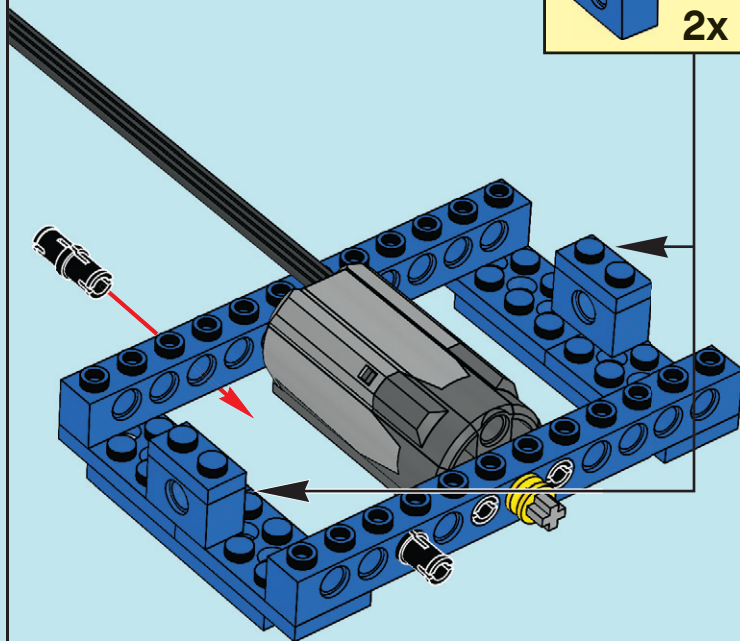
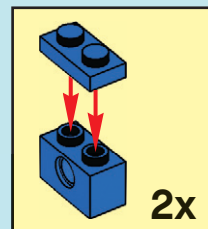



6

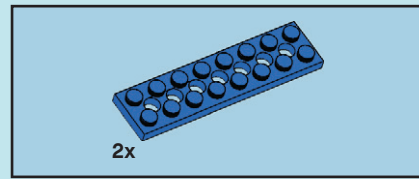
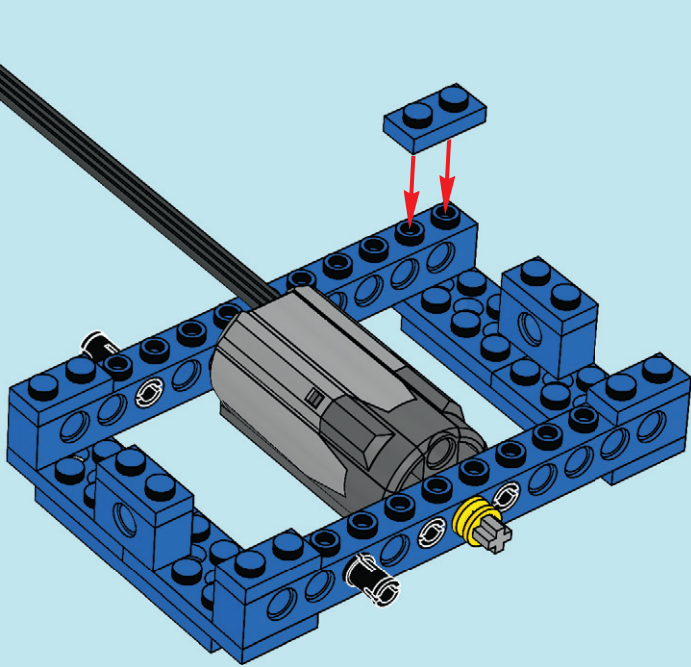

7

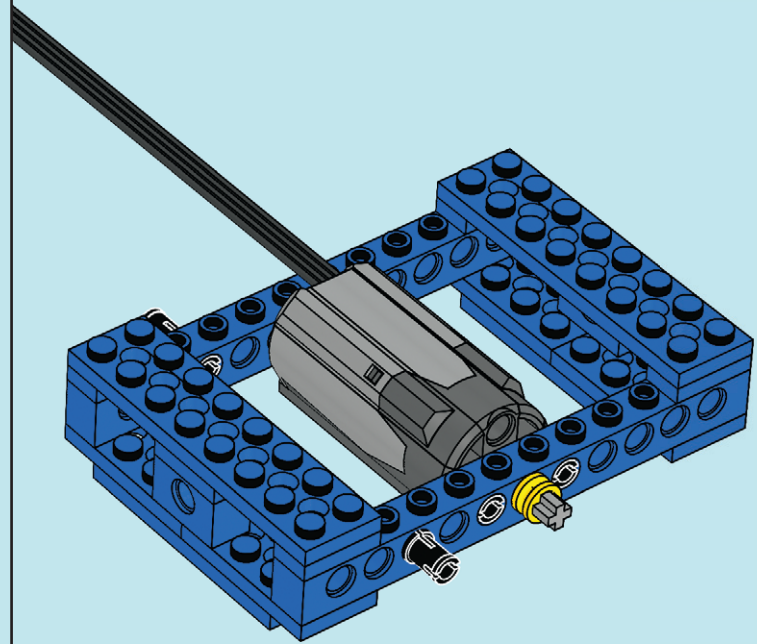

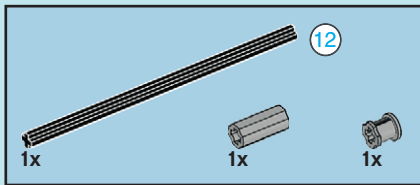

8

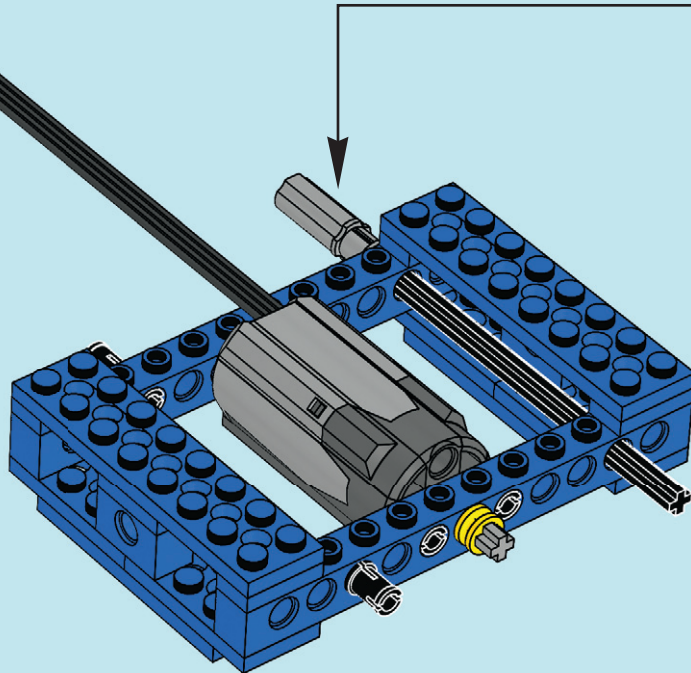
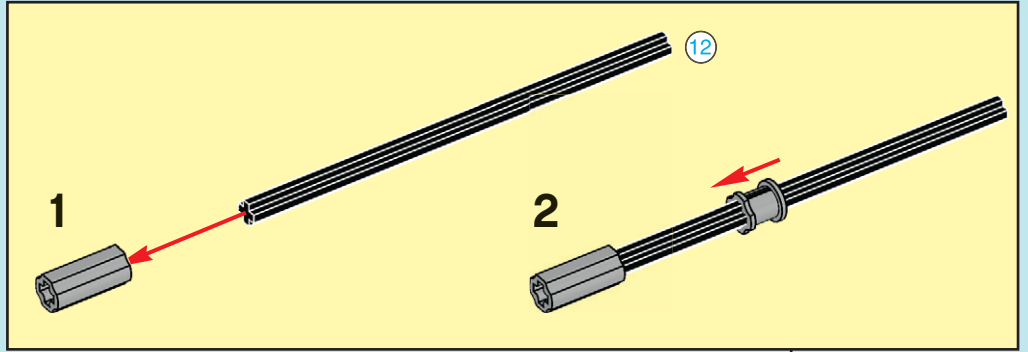

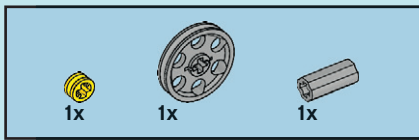

9

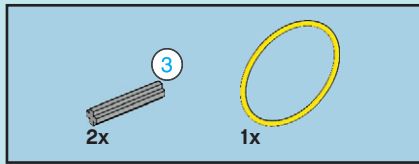
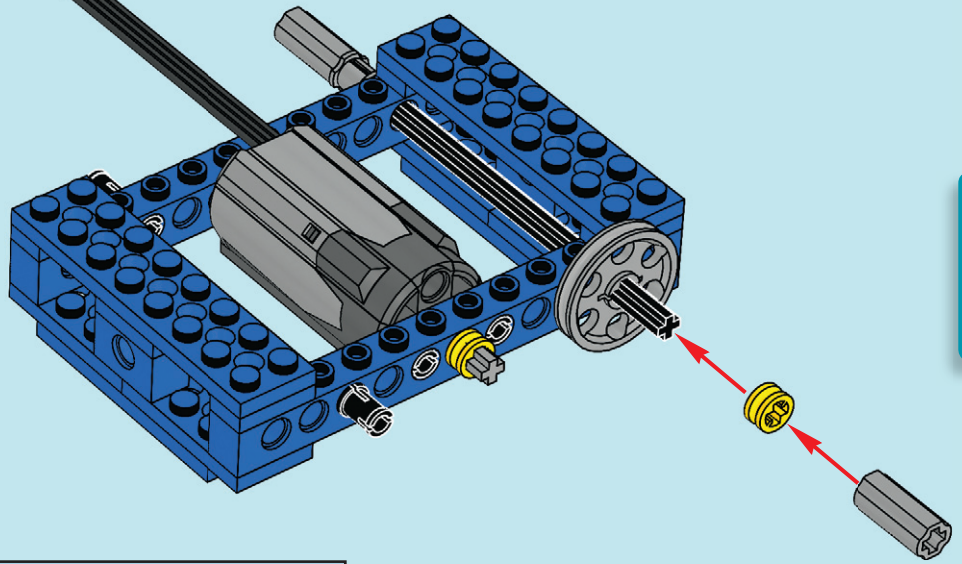

10

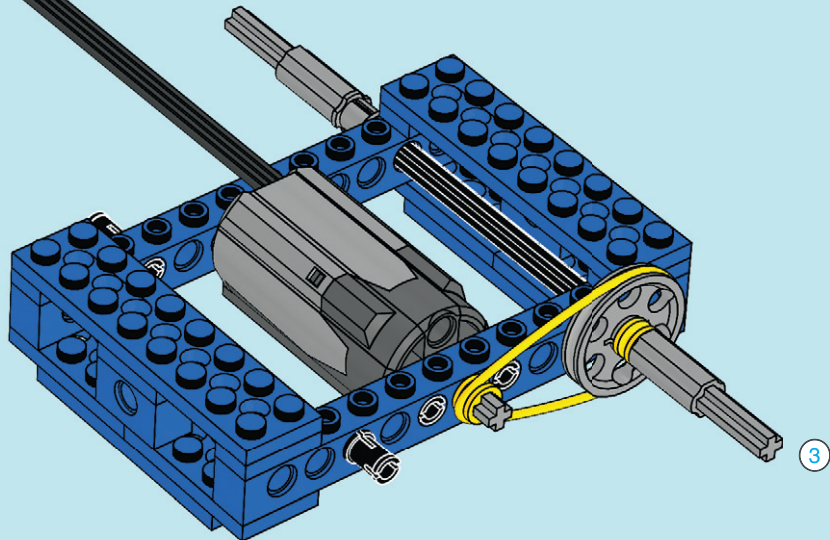
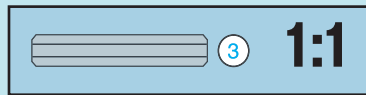

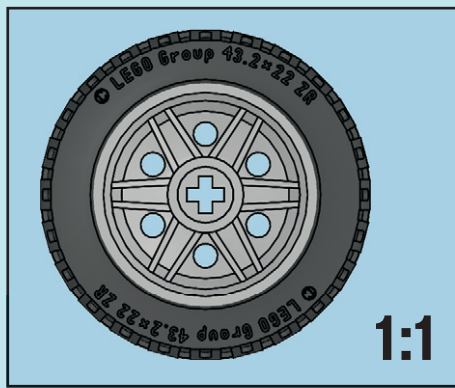
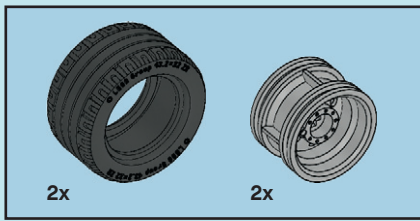

11

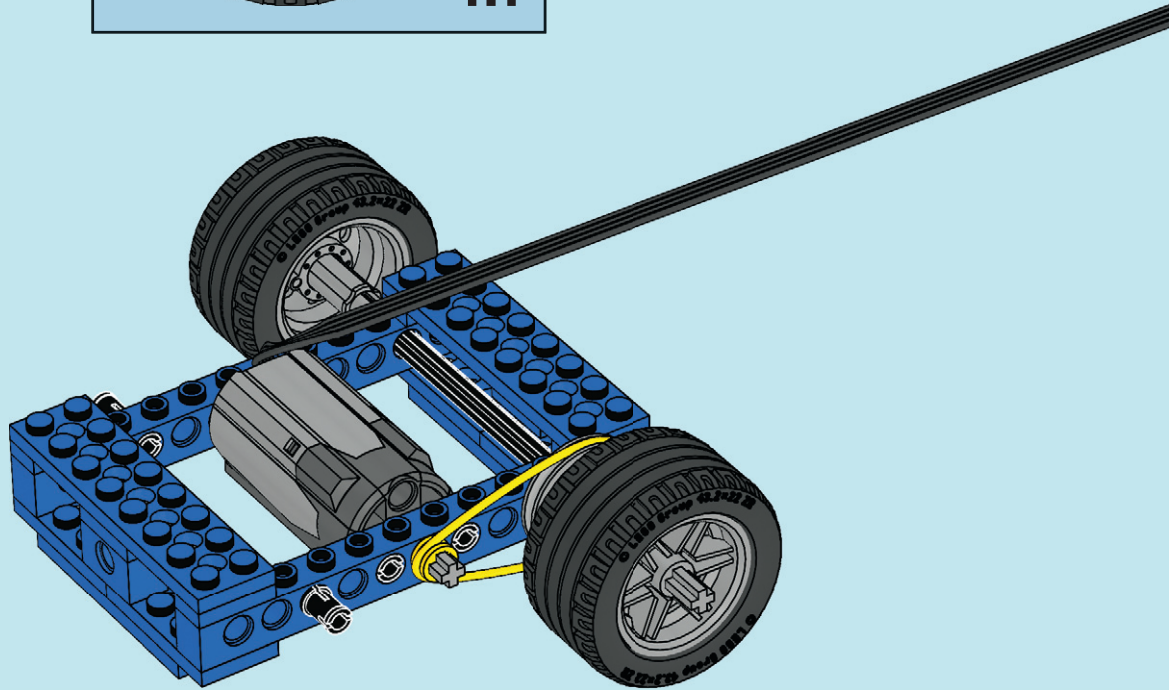

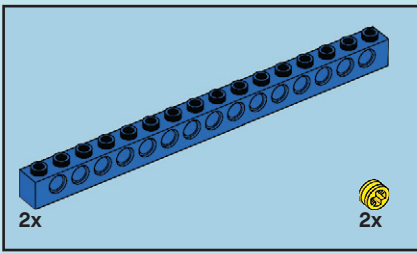

12

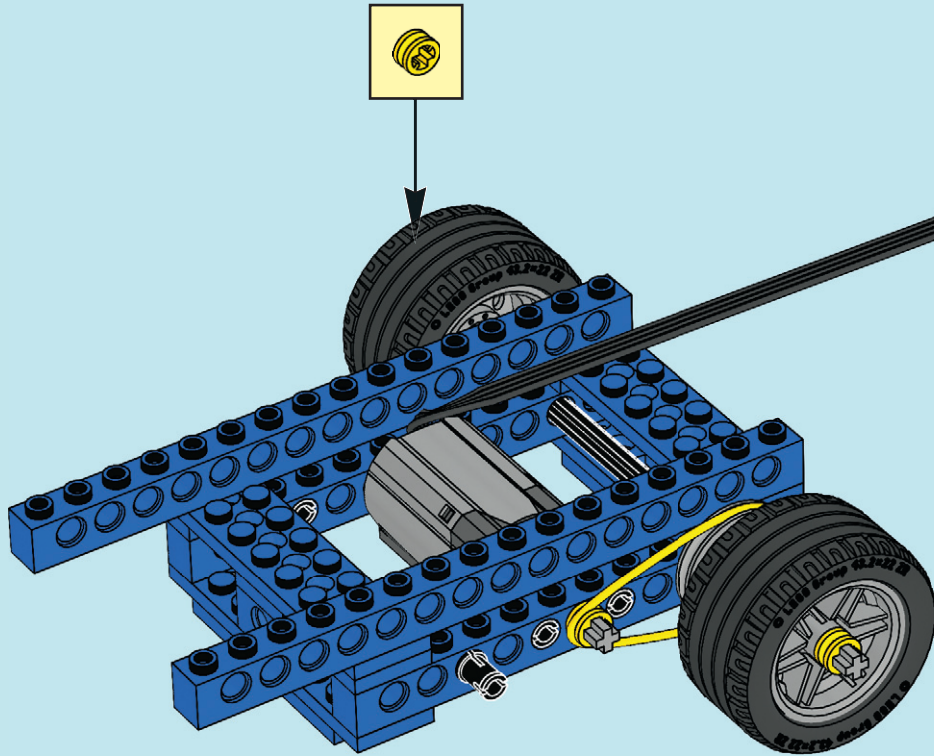

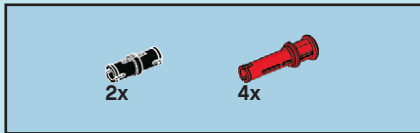

13

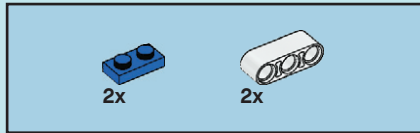
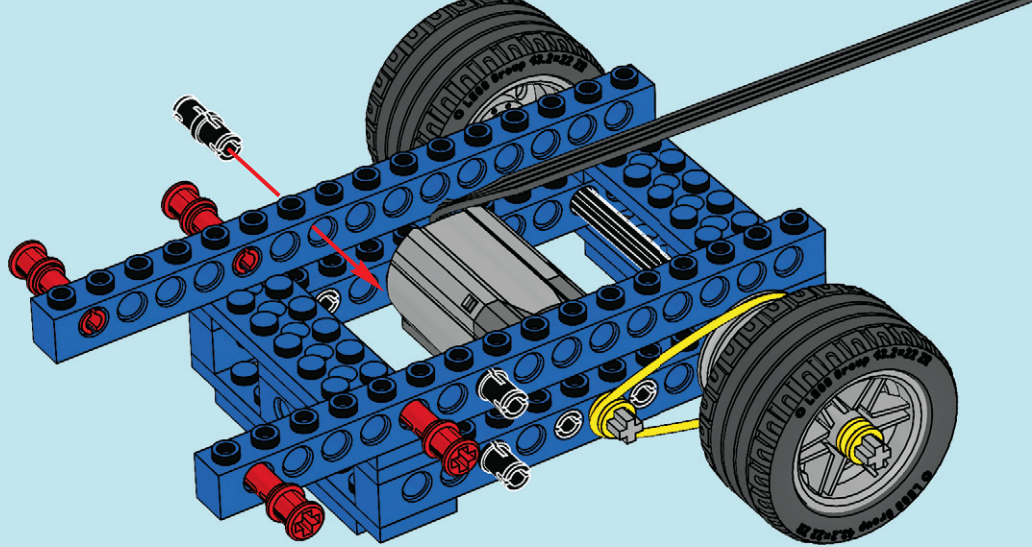

14

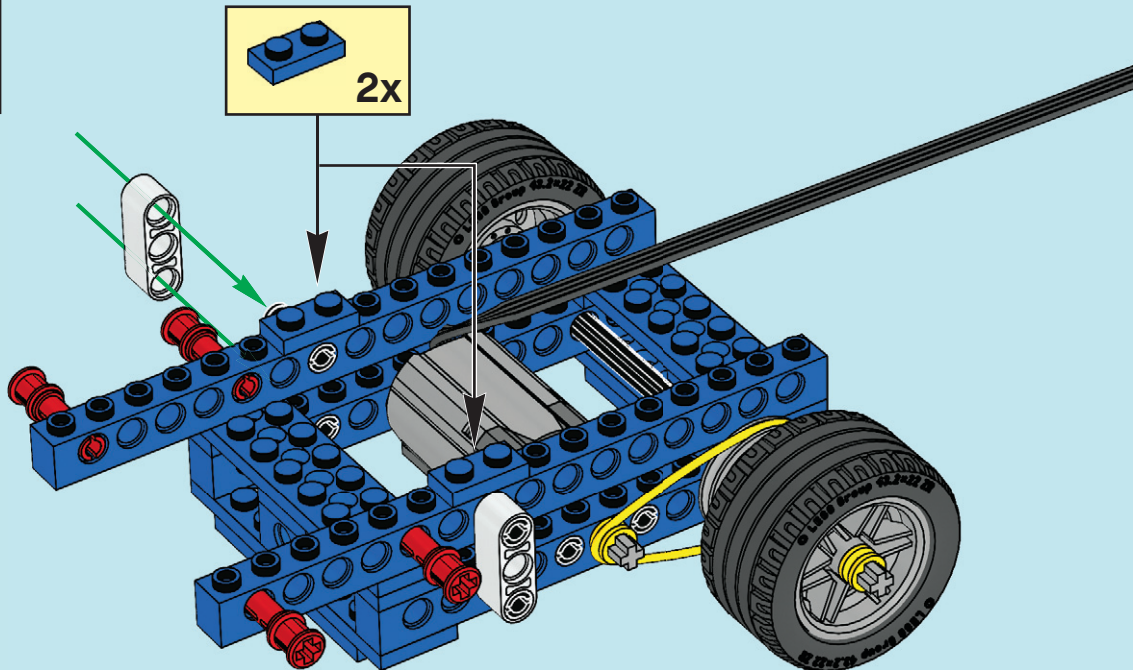

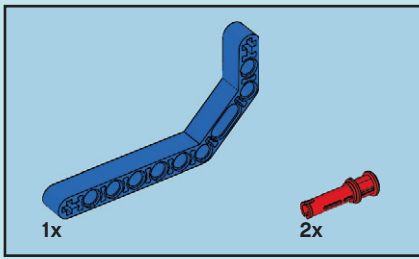

15

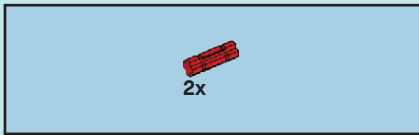
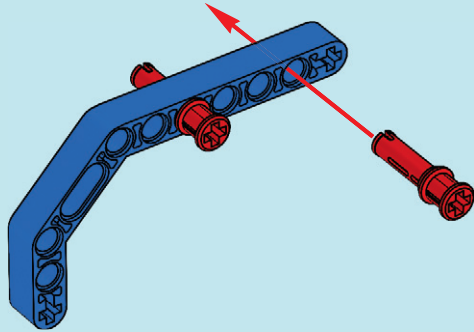

16

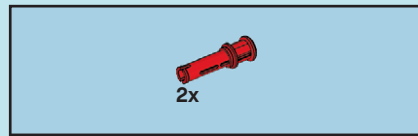
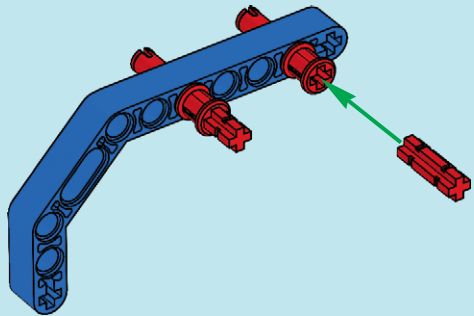

17

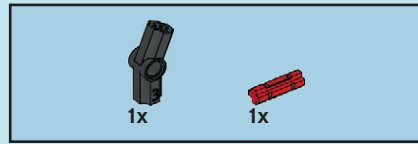
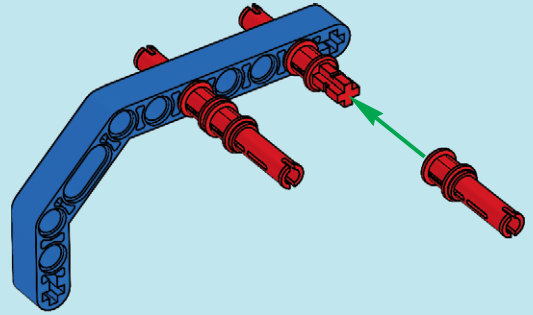

18

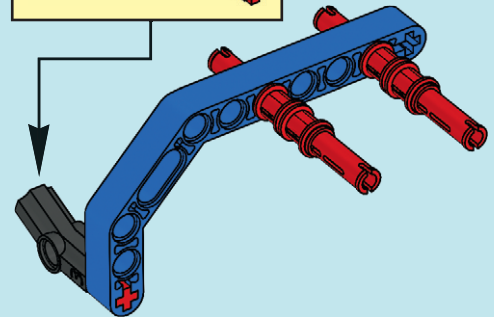
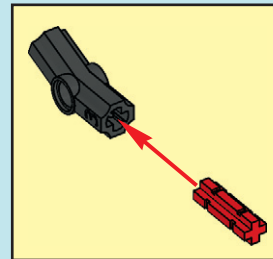

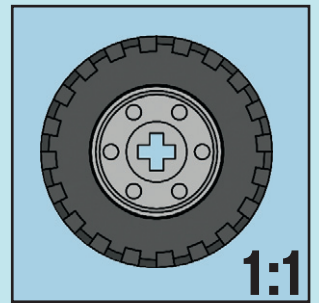
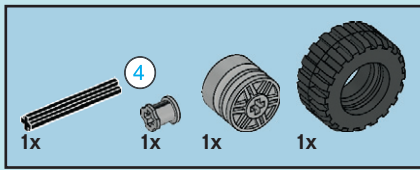

19

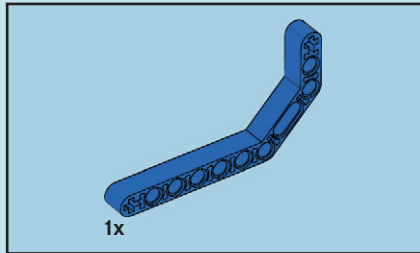
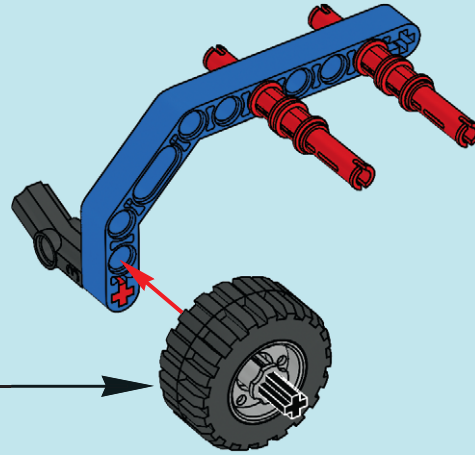
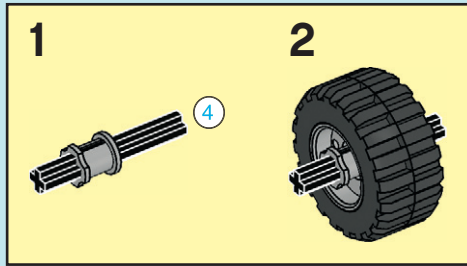

20

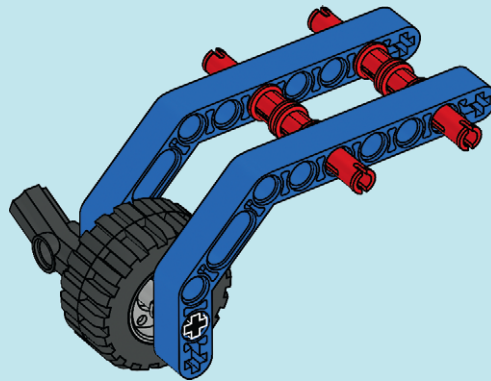

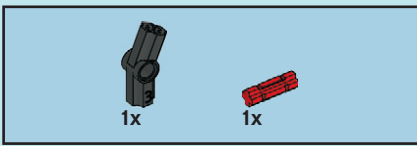

21

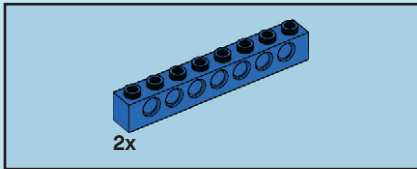
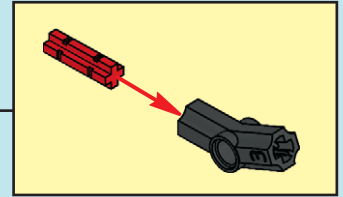
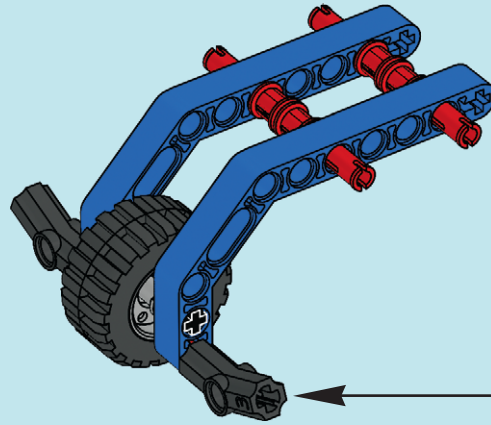

22

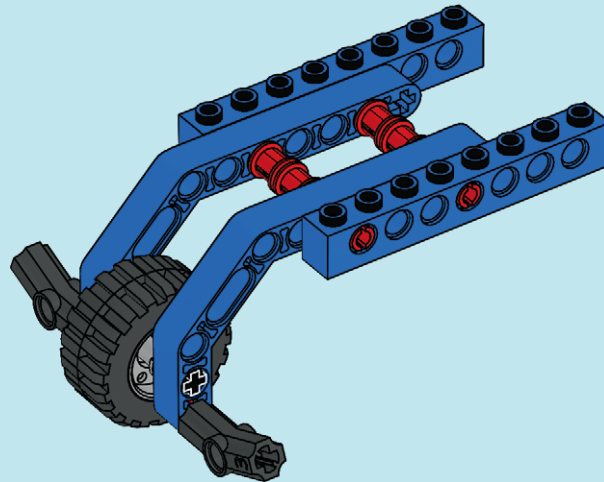

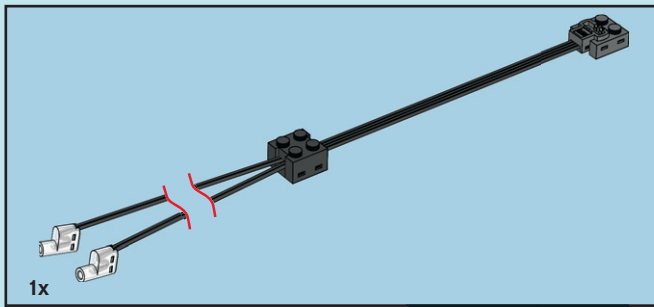

23

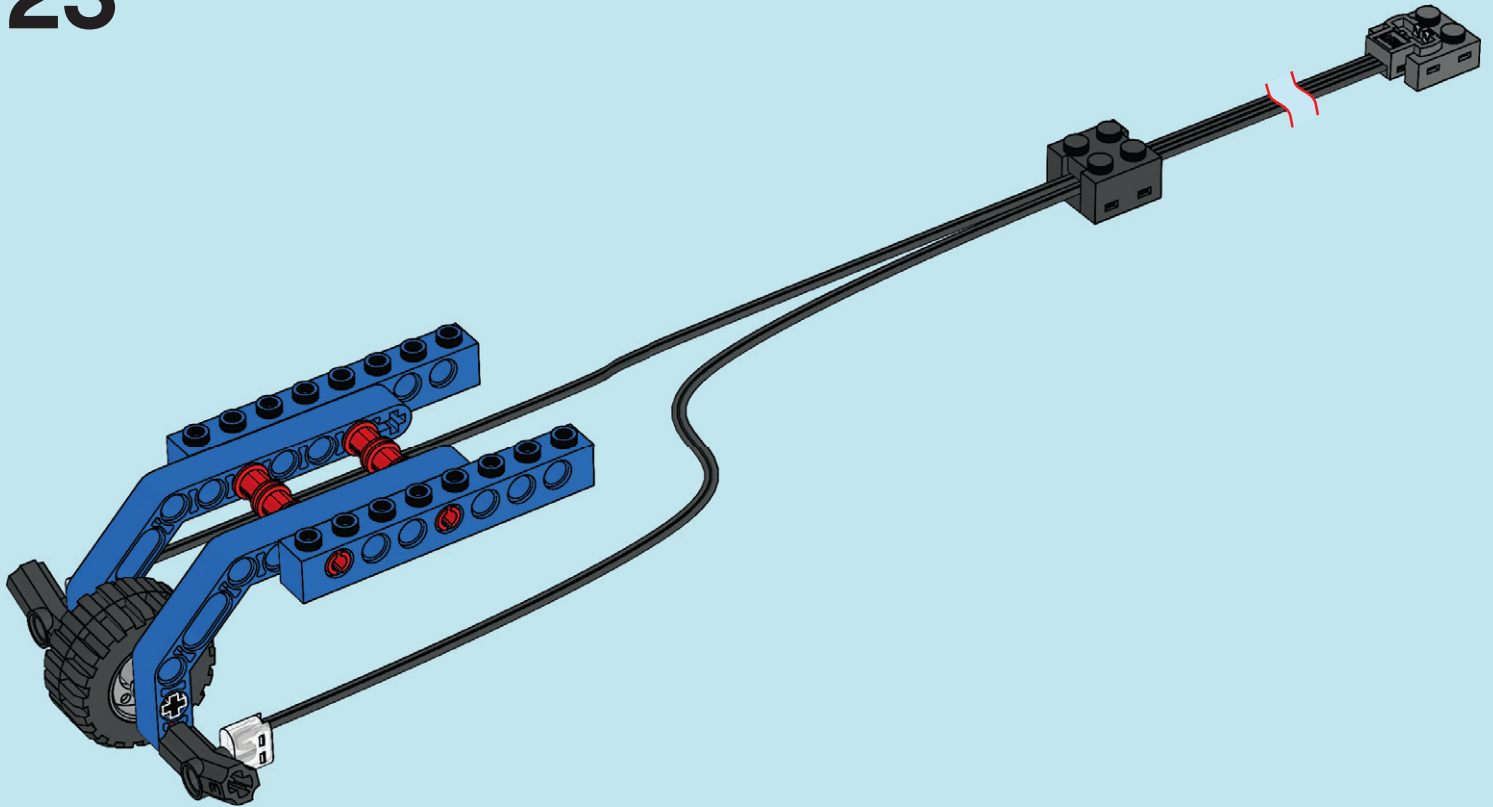

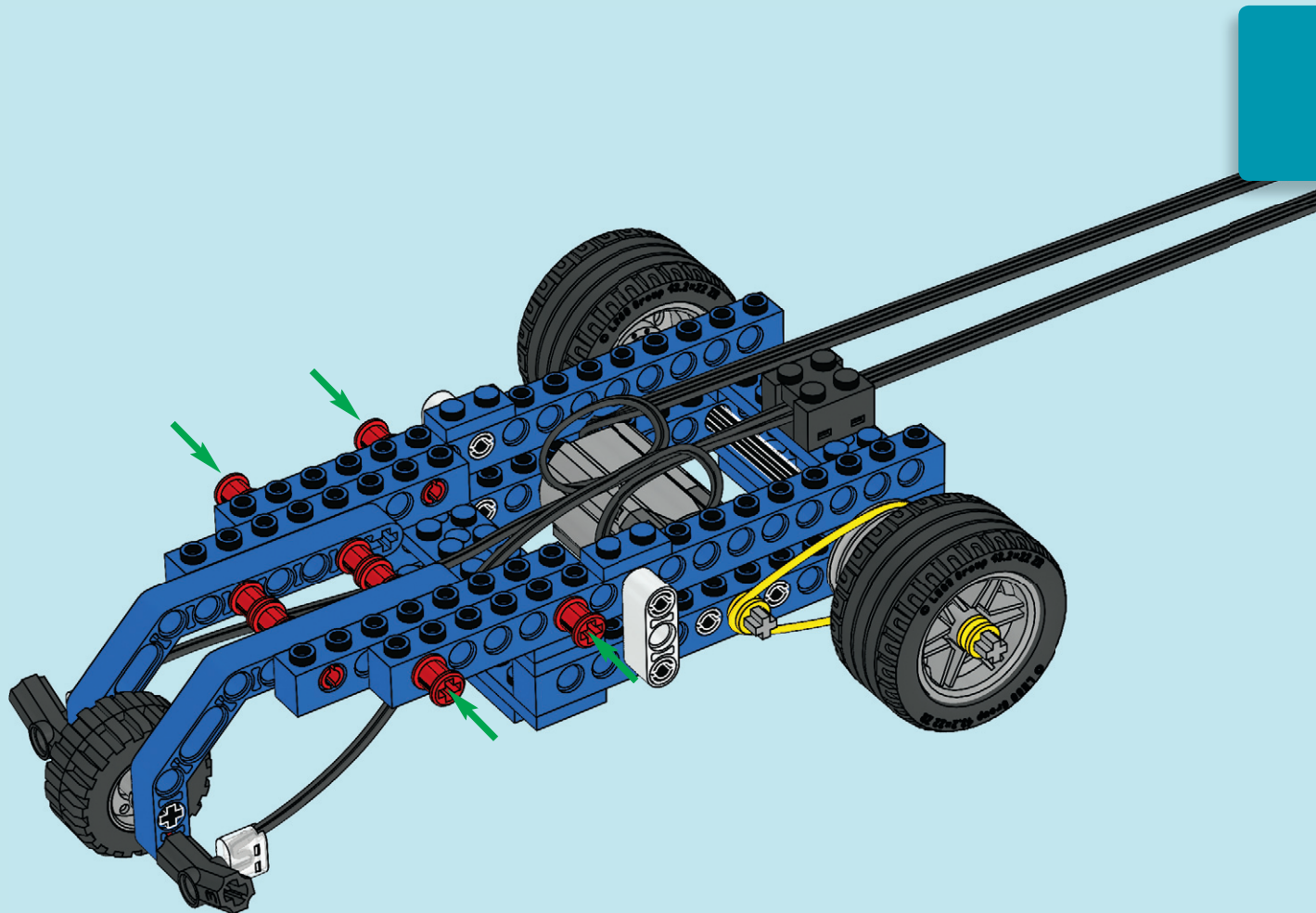

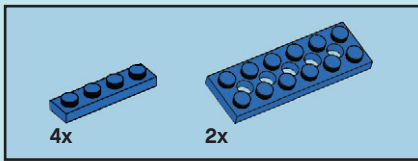

25

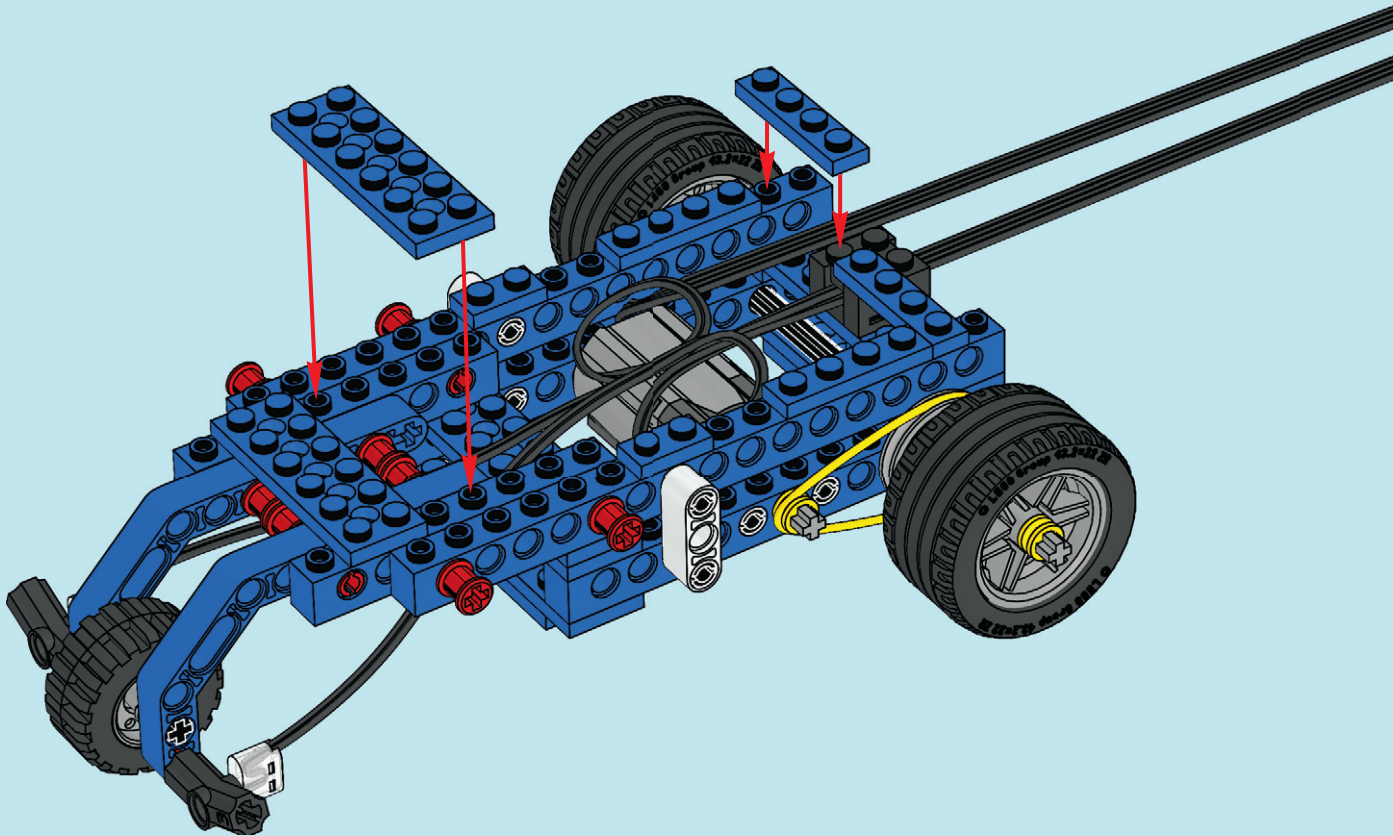

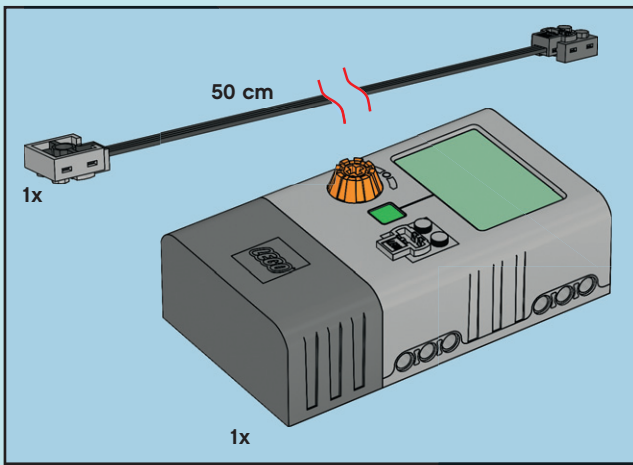

26

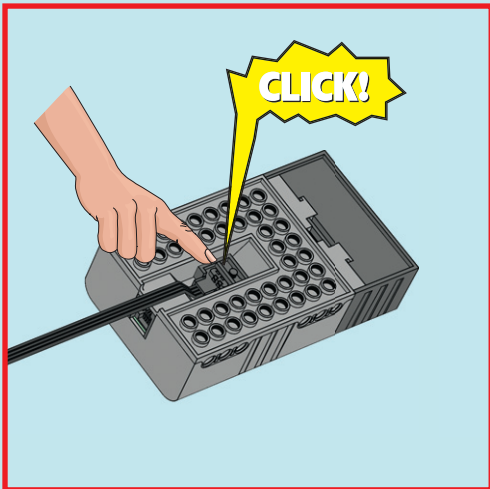
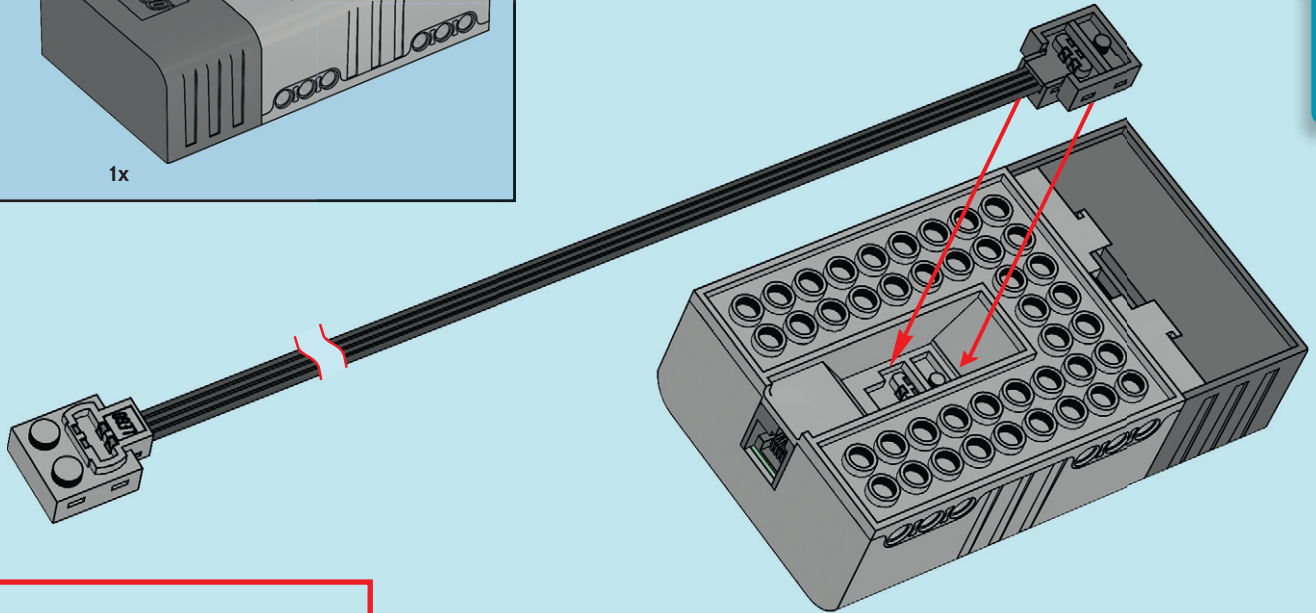

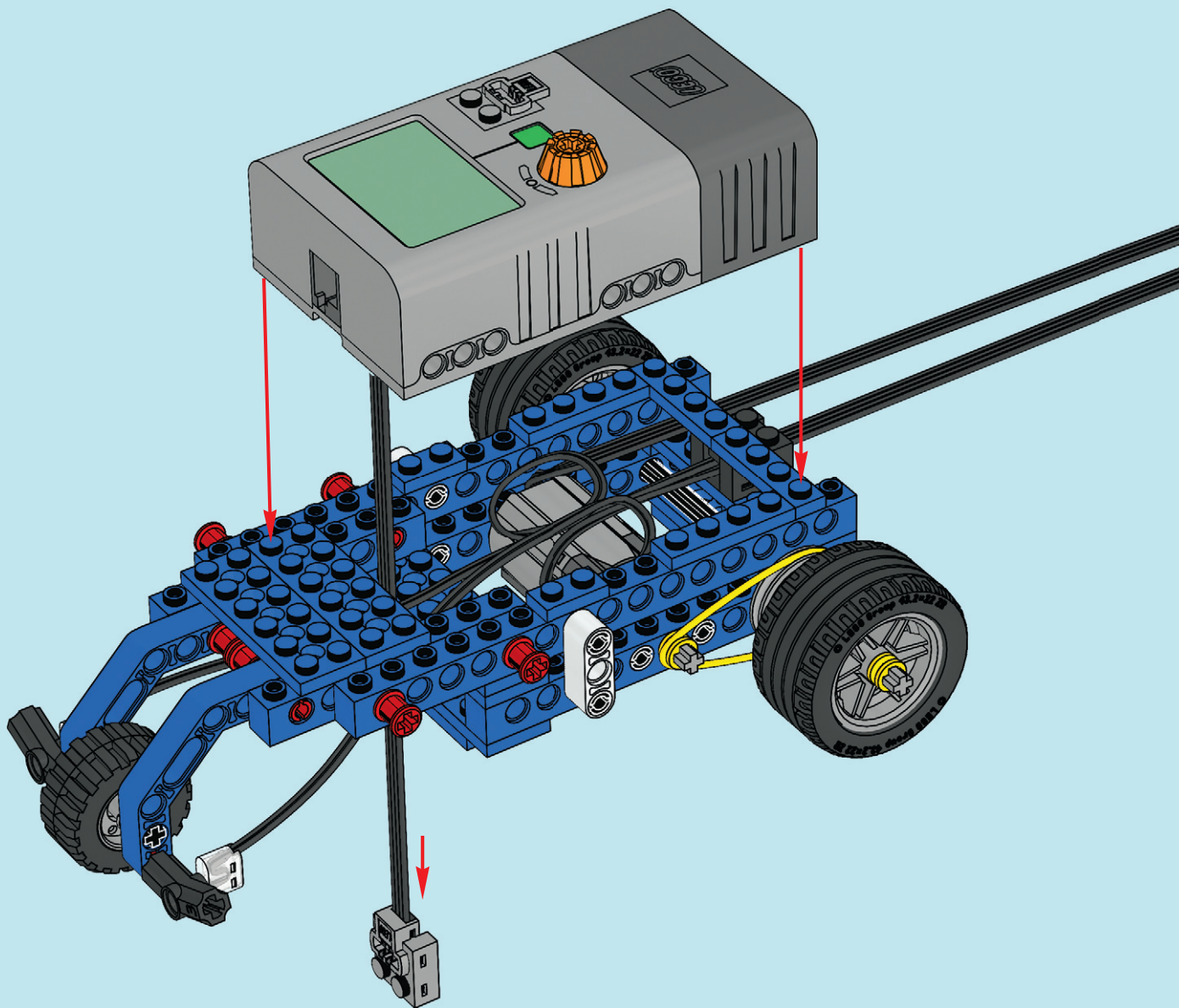

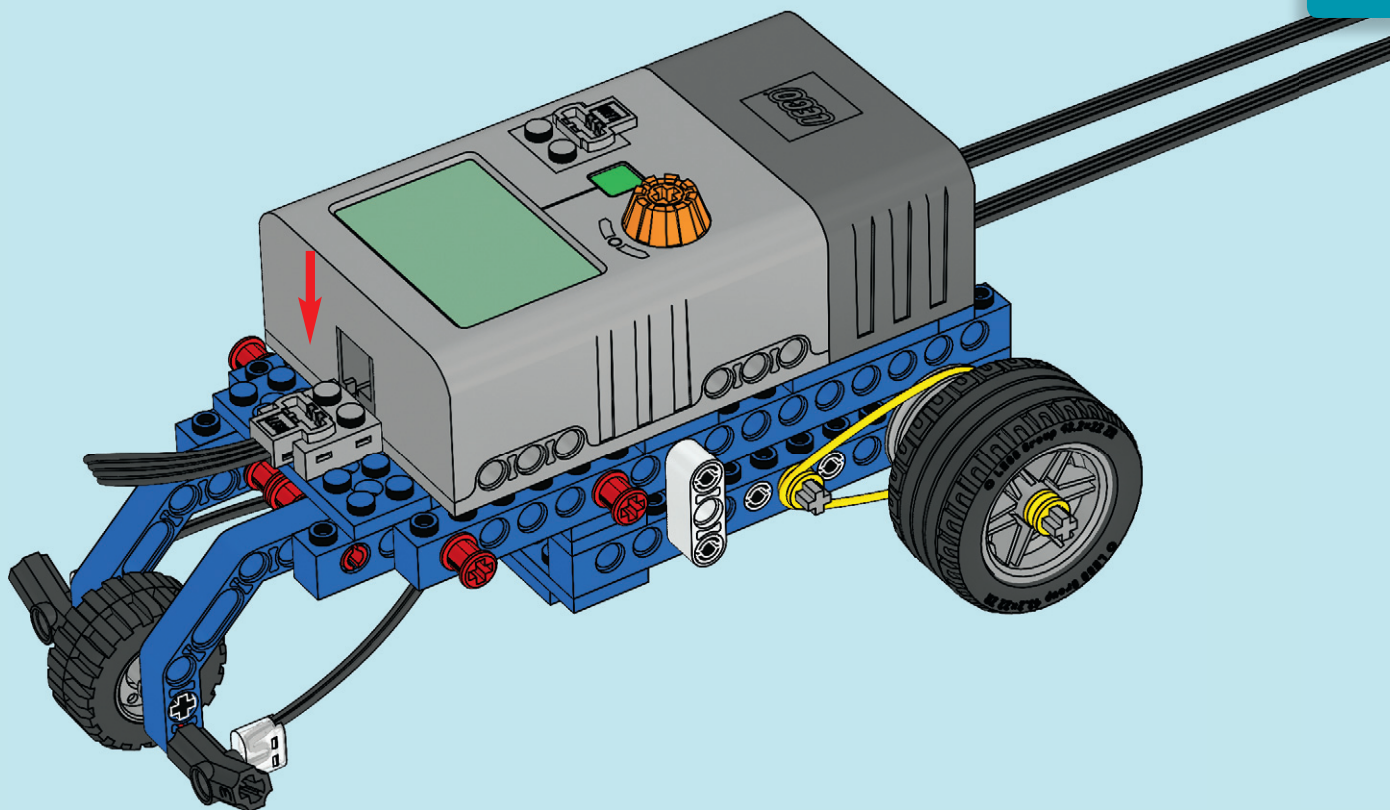

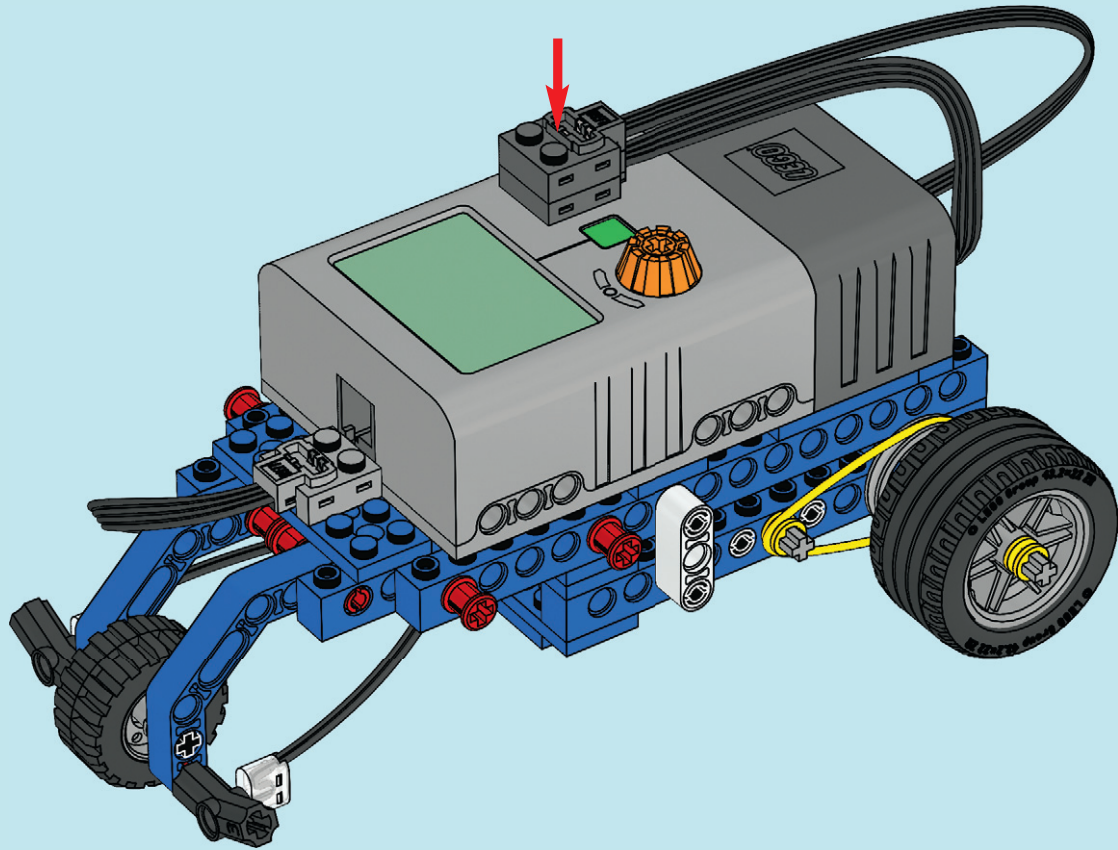

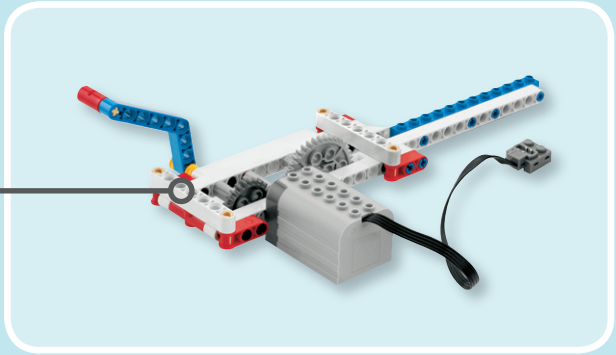
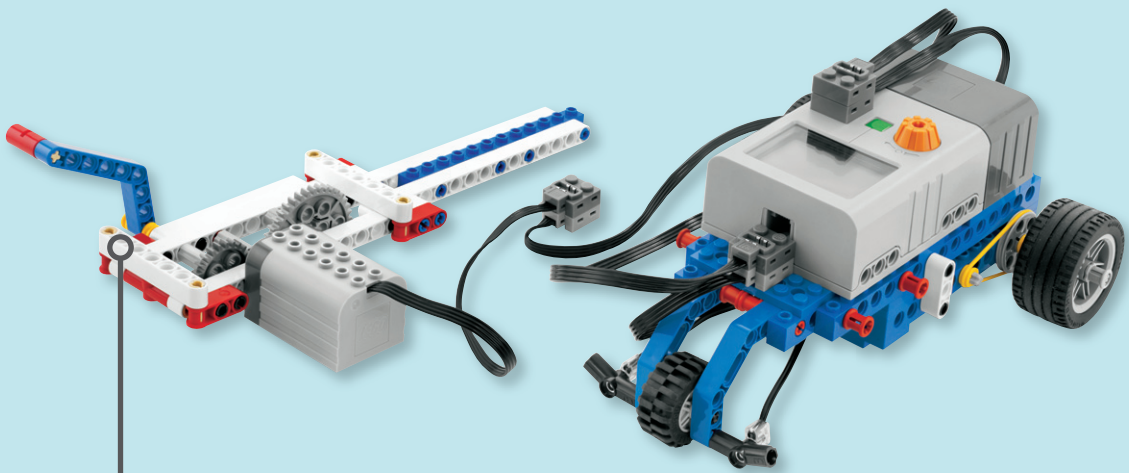

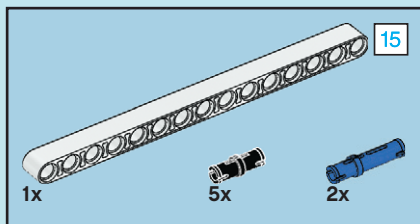

1

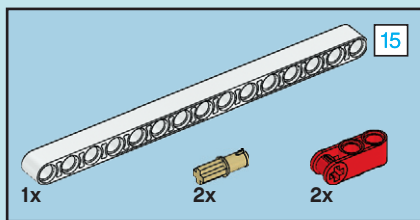
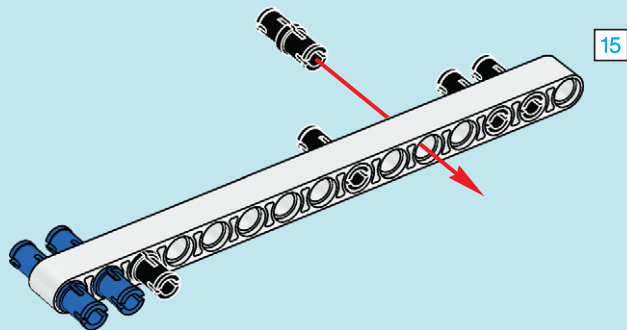

2

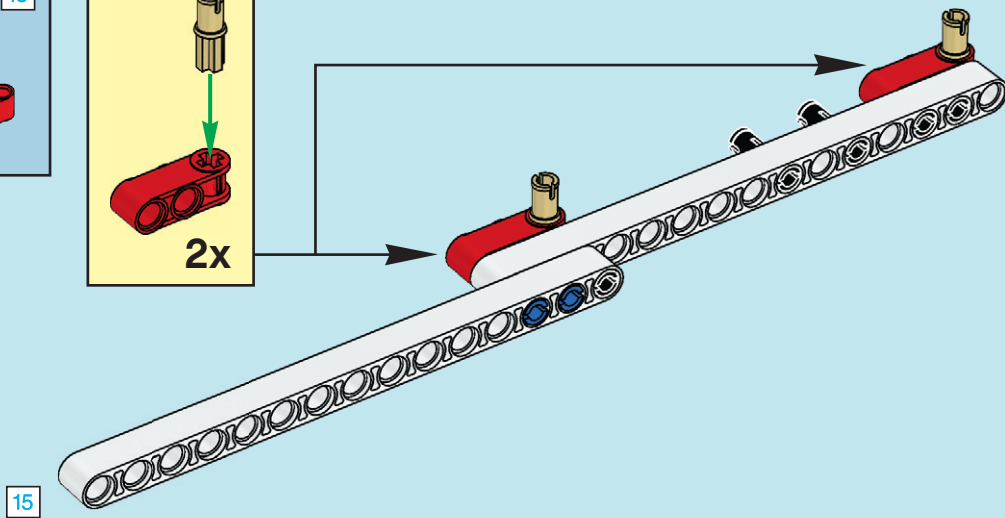
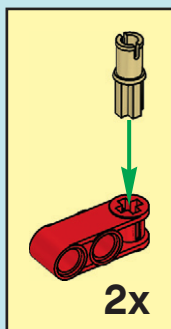

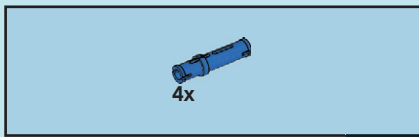

3

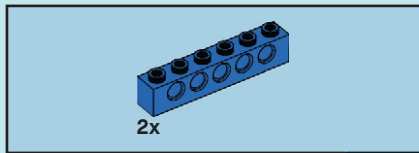
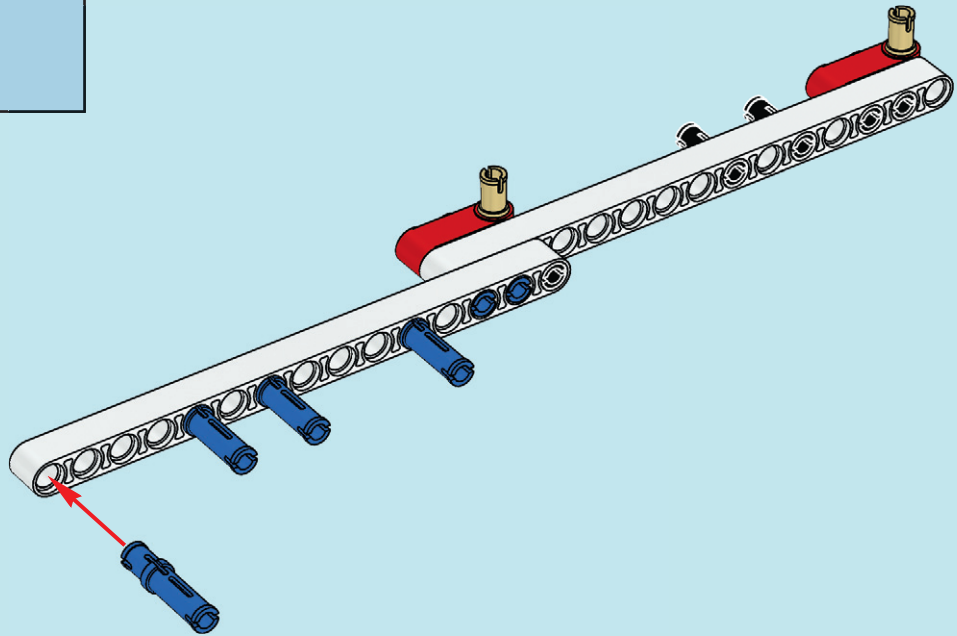

4

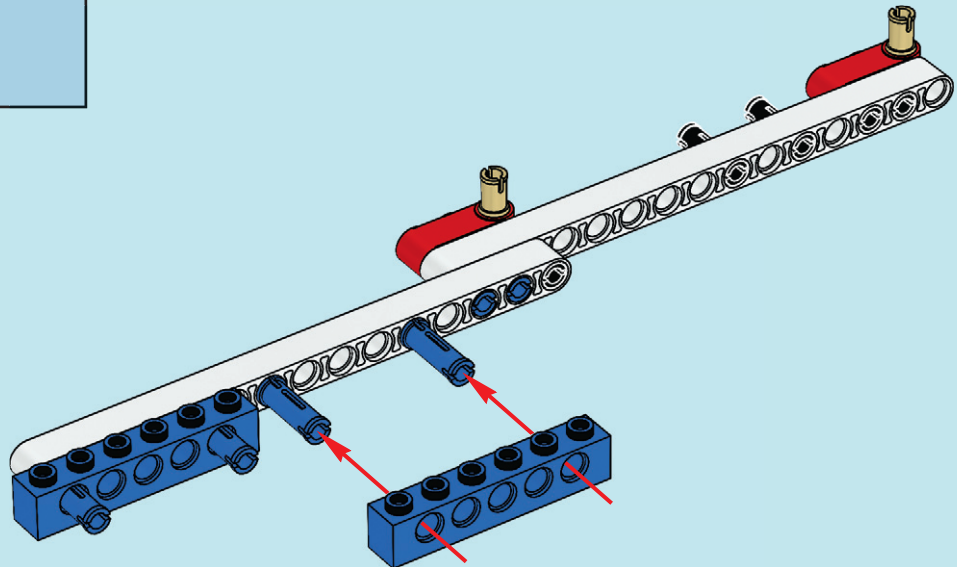

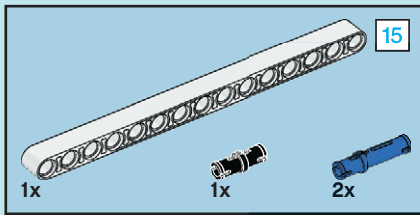

5

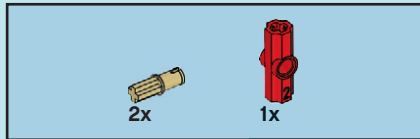
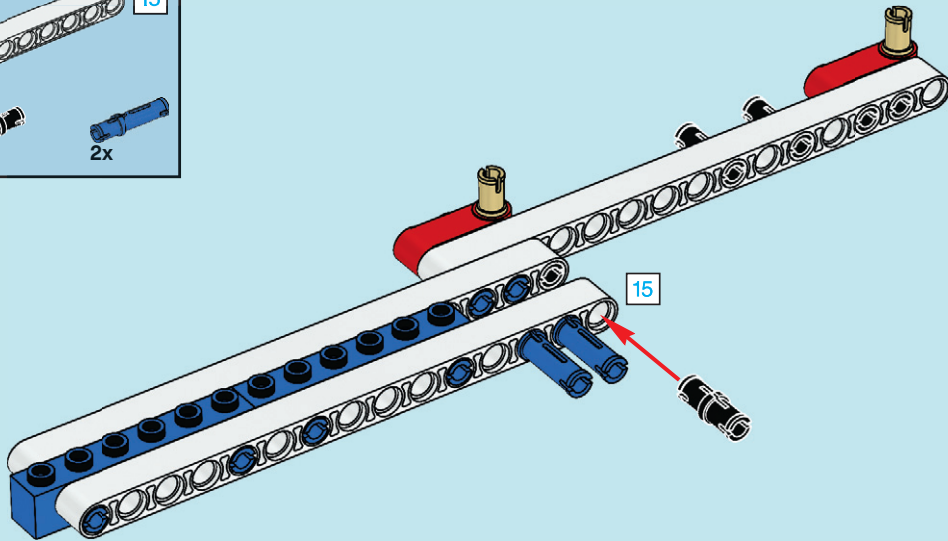

6

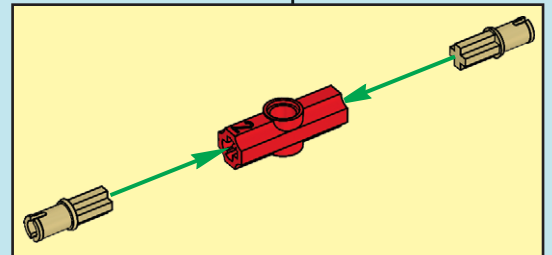
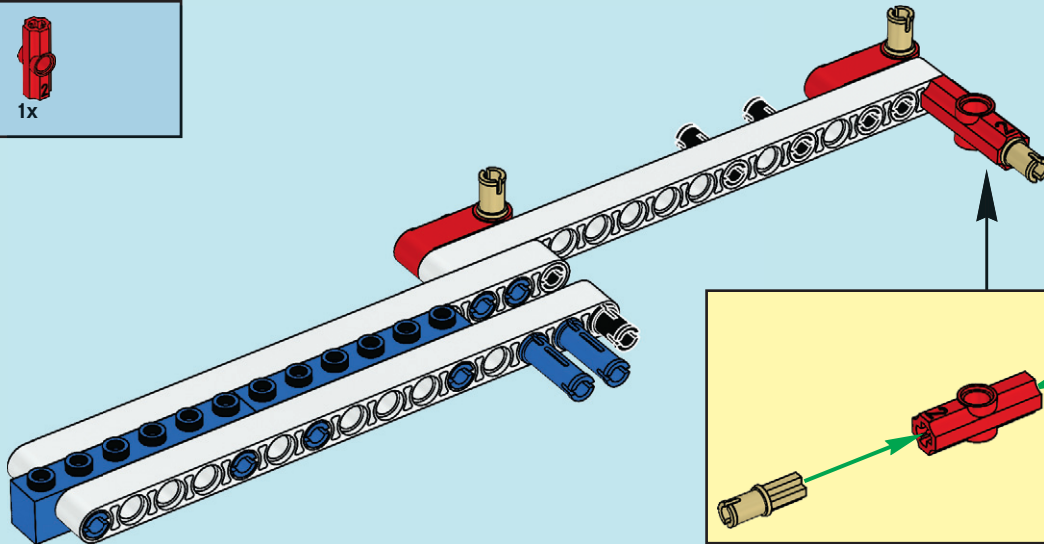

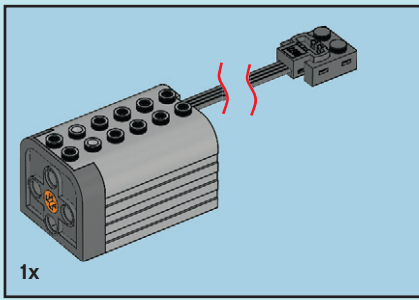

7

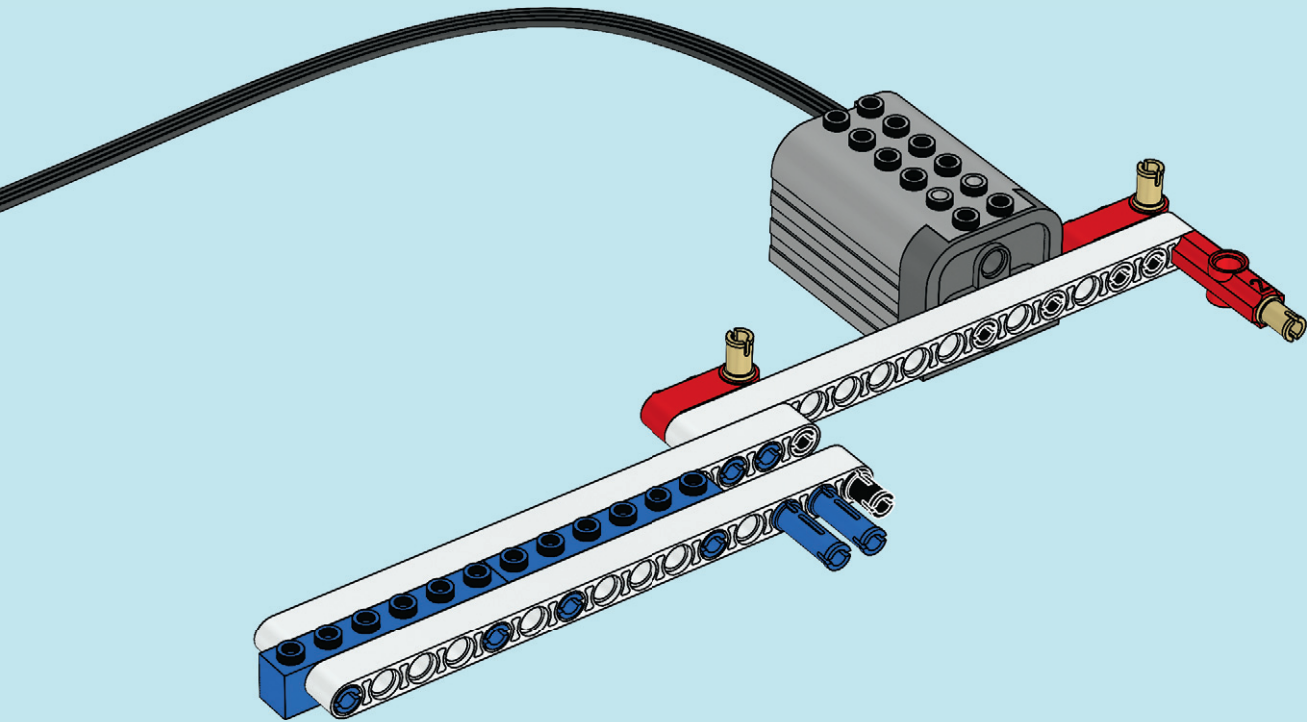

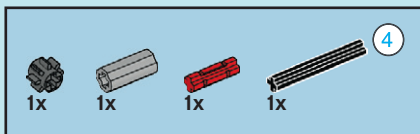

8

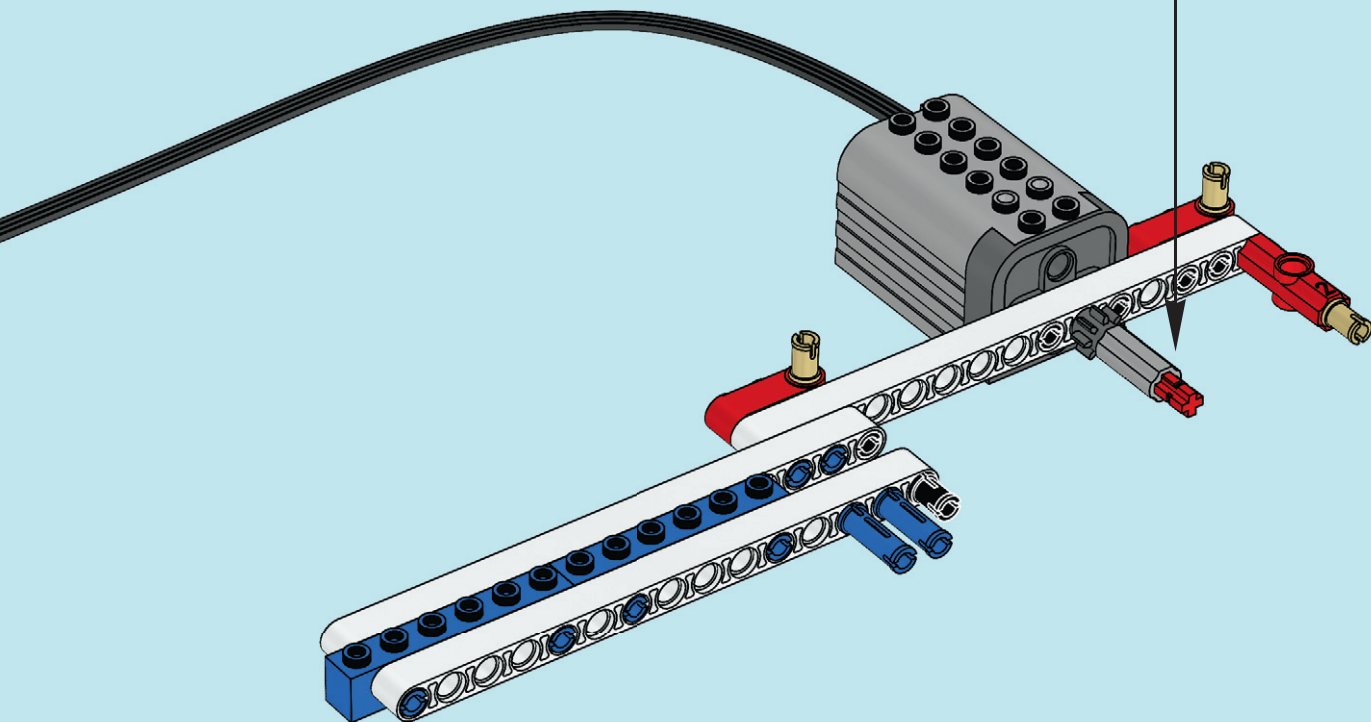
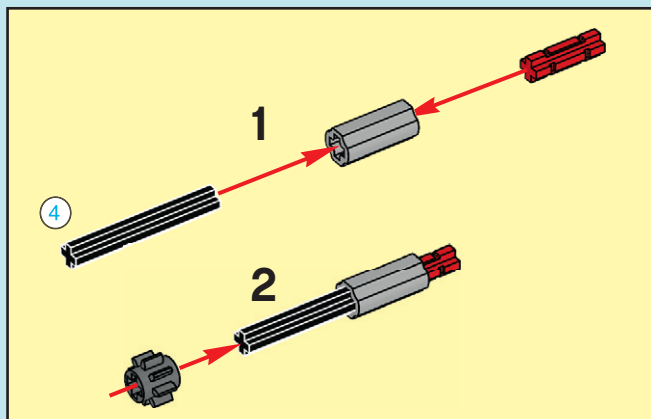

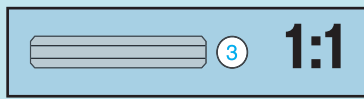
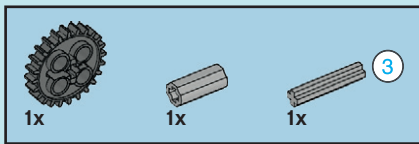

9

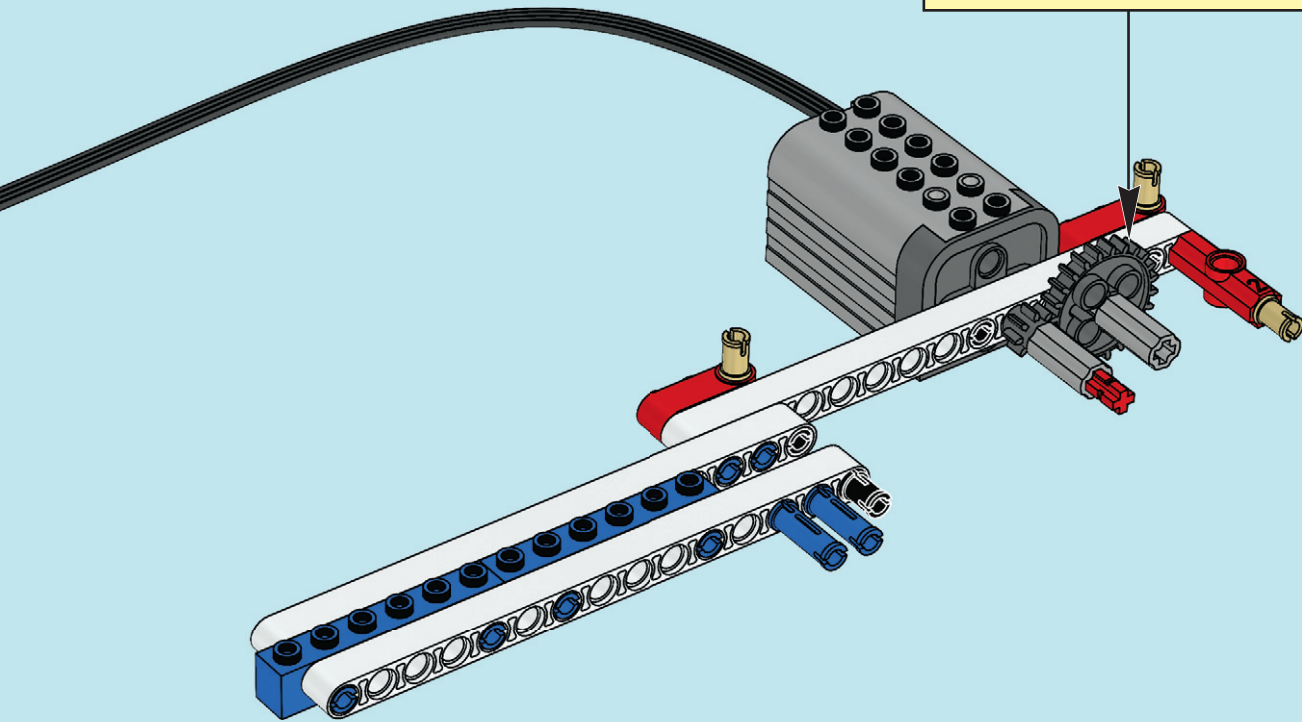
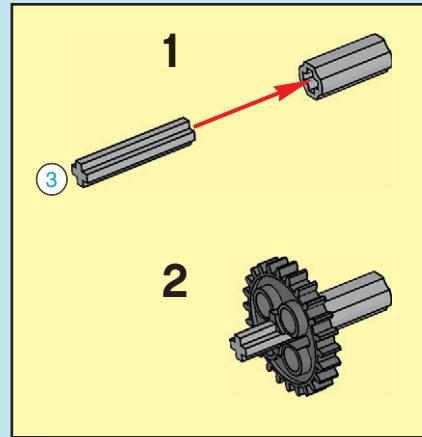

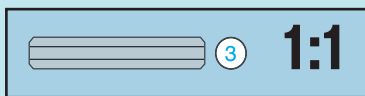
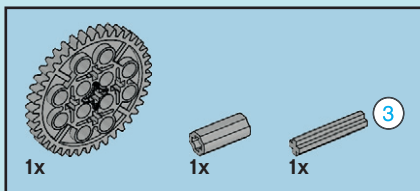

10

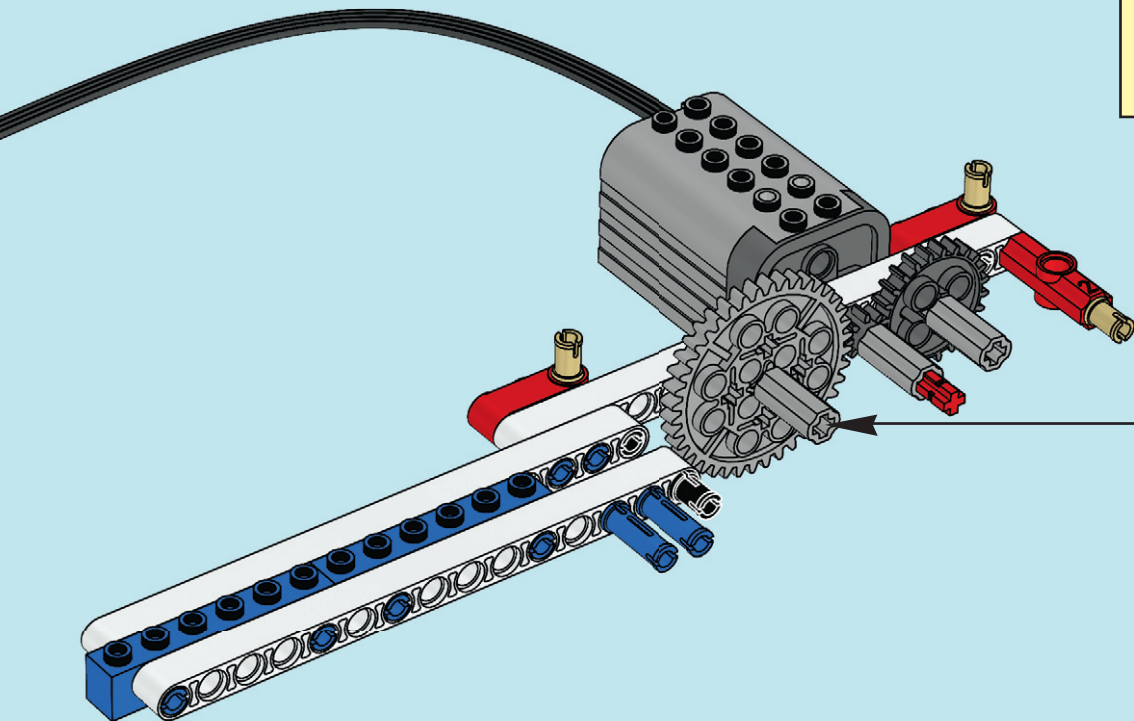
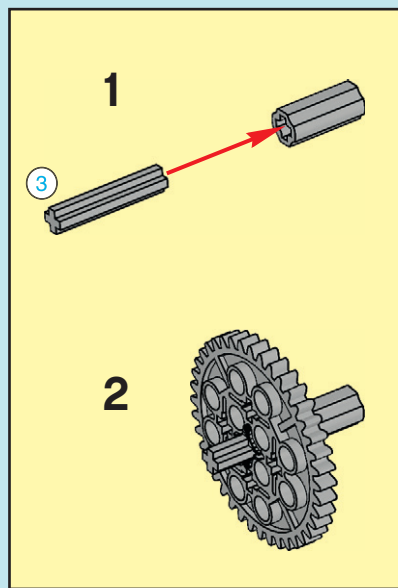

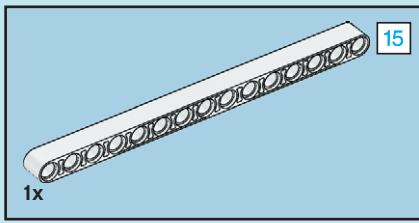

11

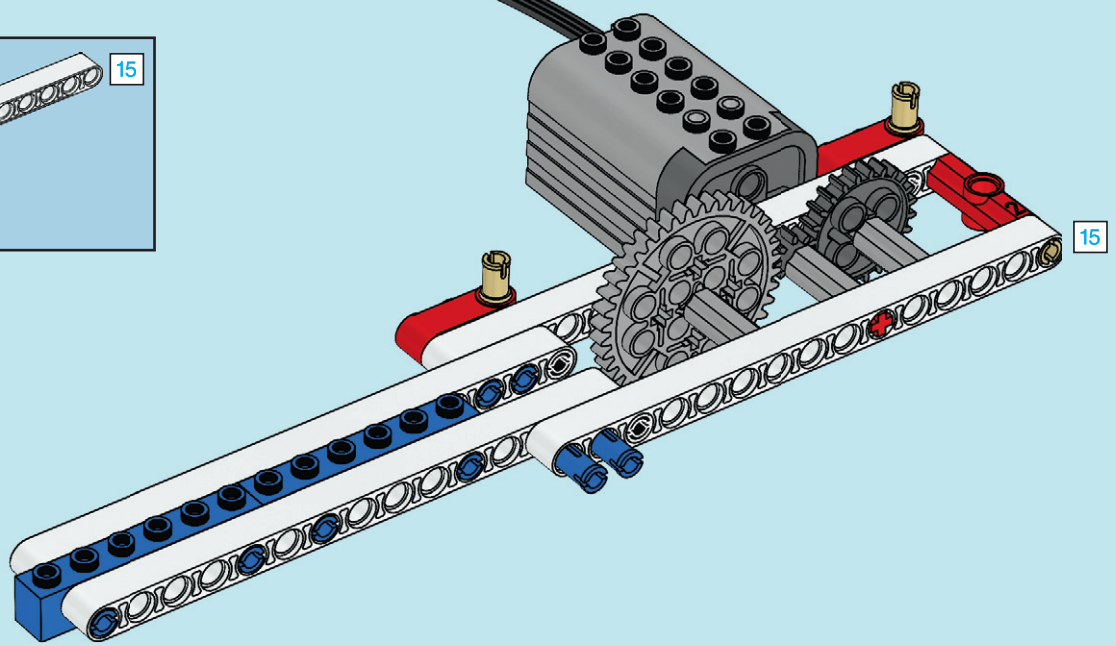

12

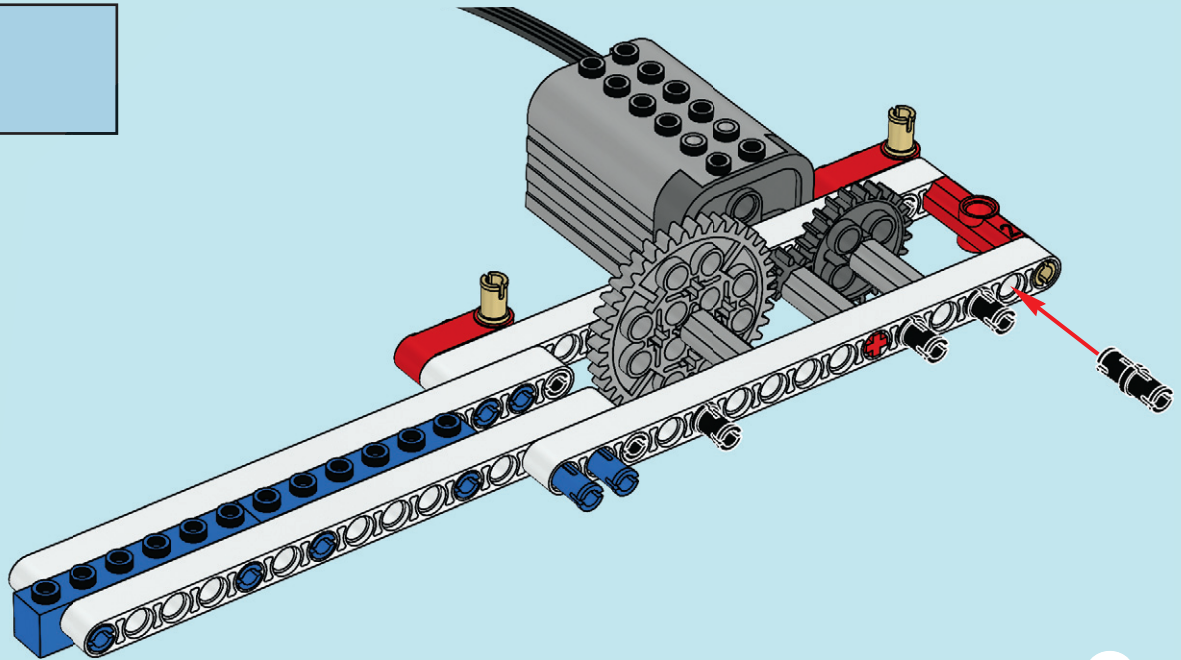

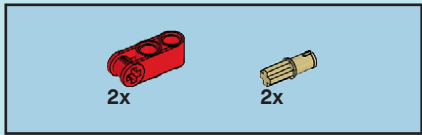

13

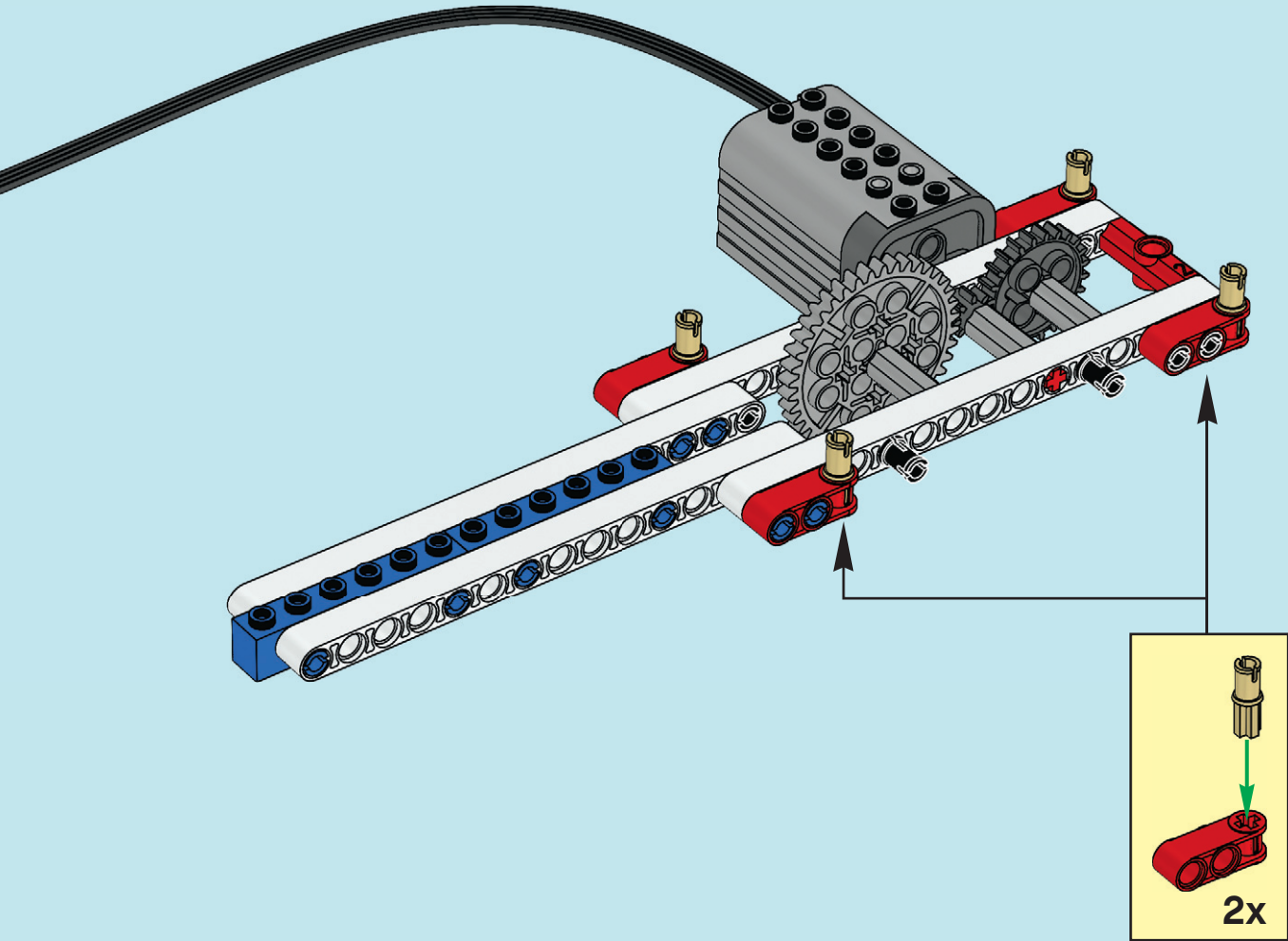

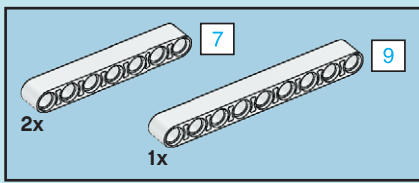

14

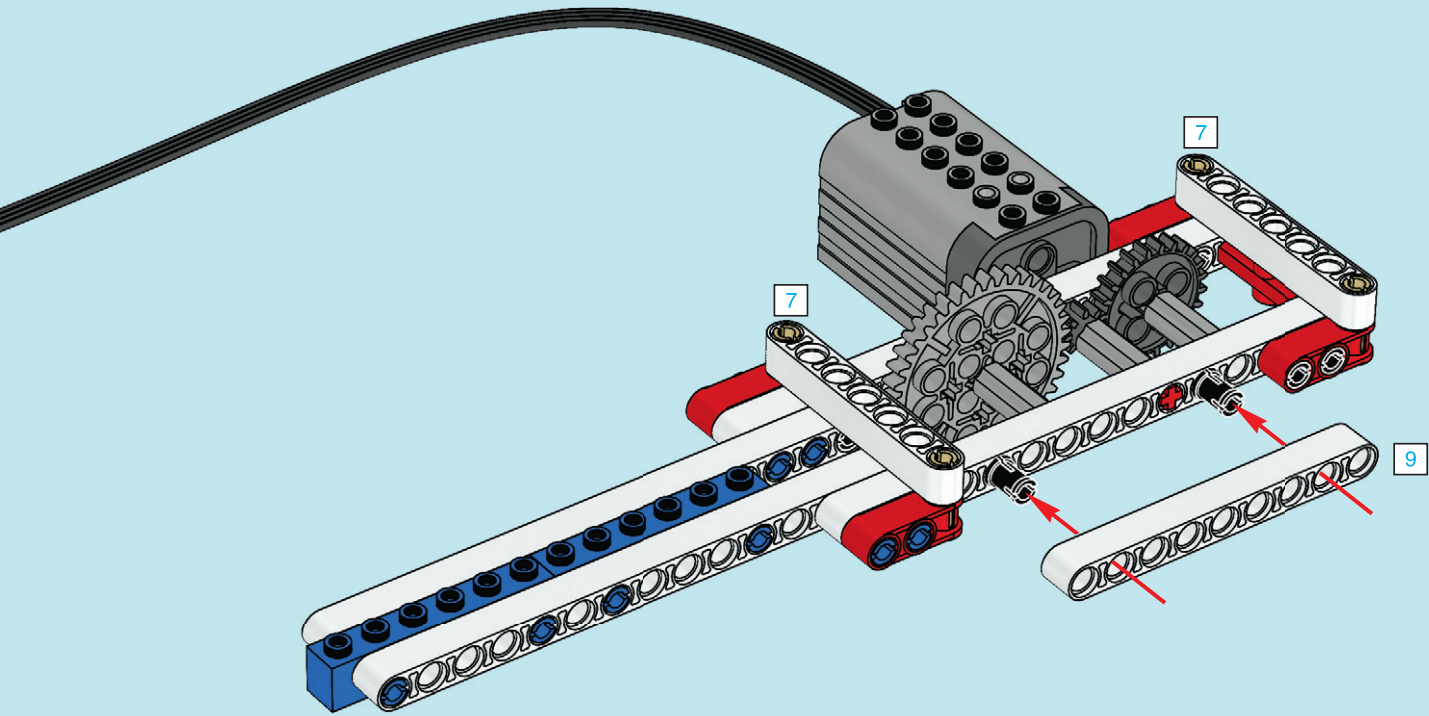

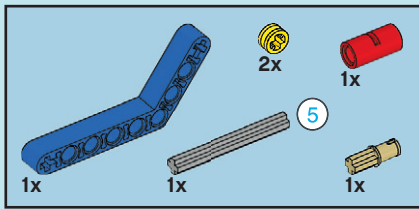

15

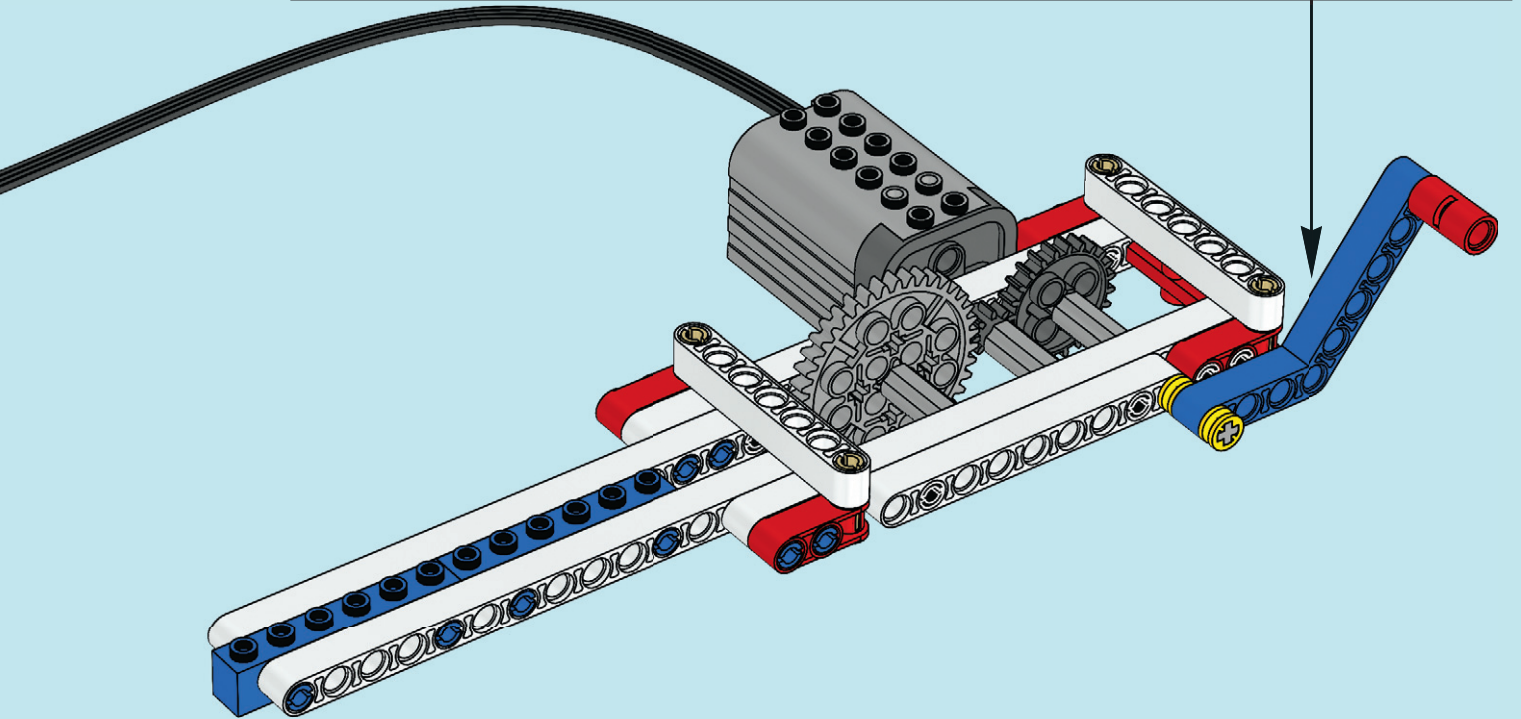
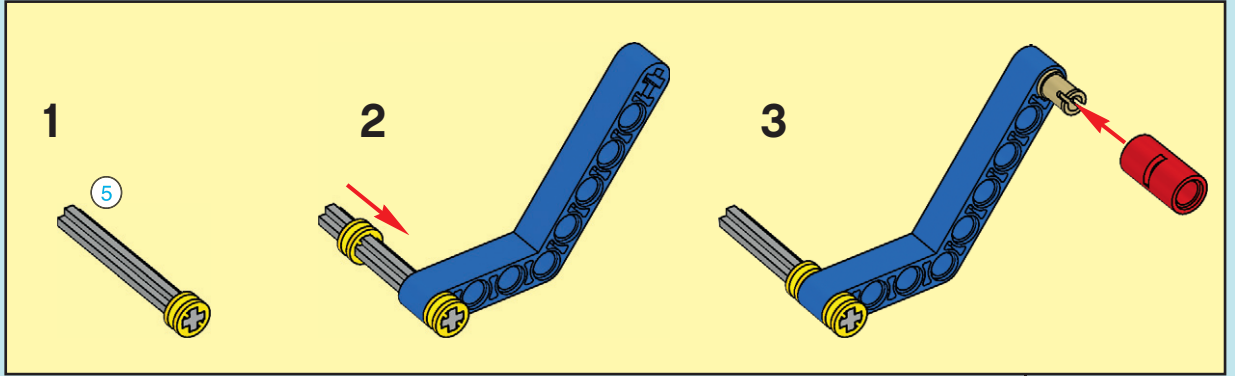

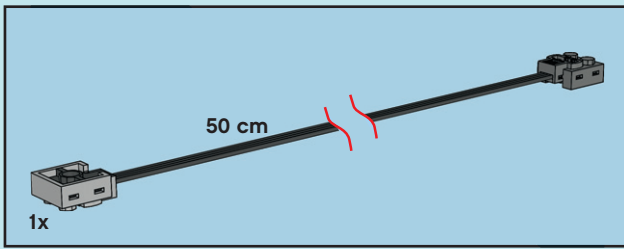

16

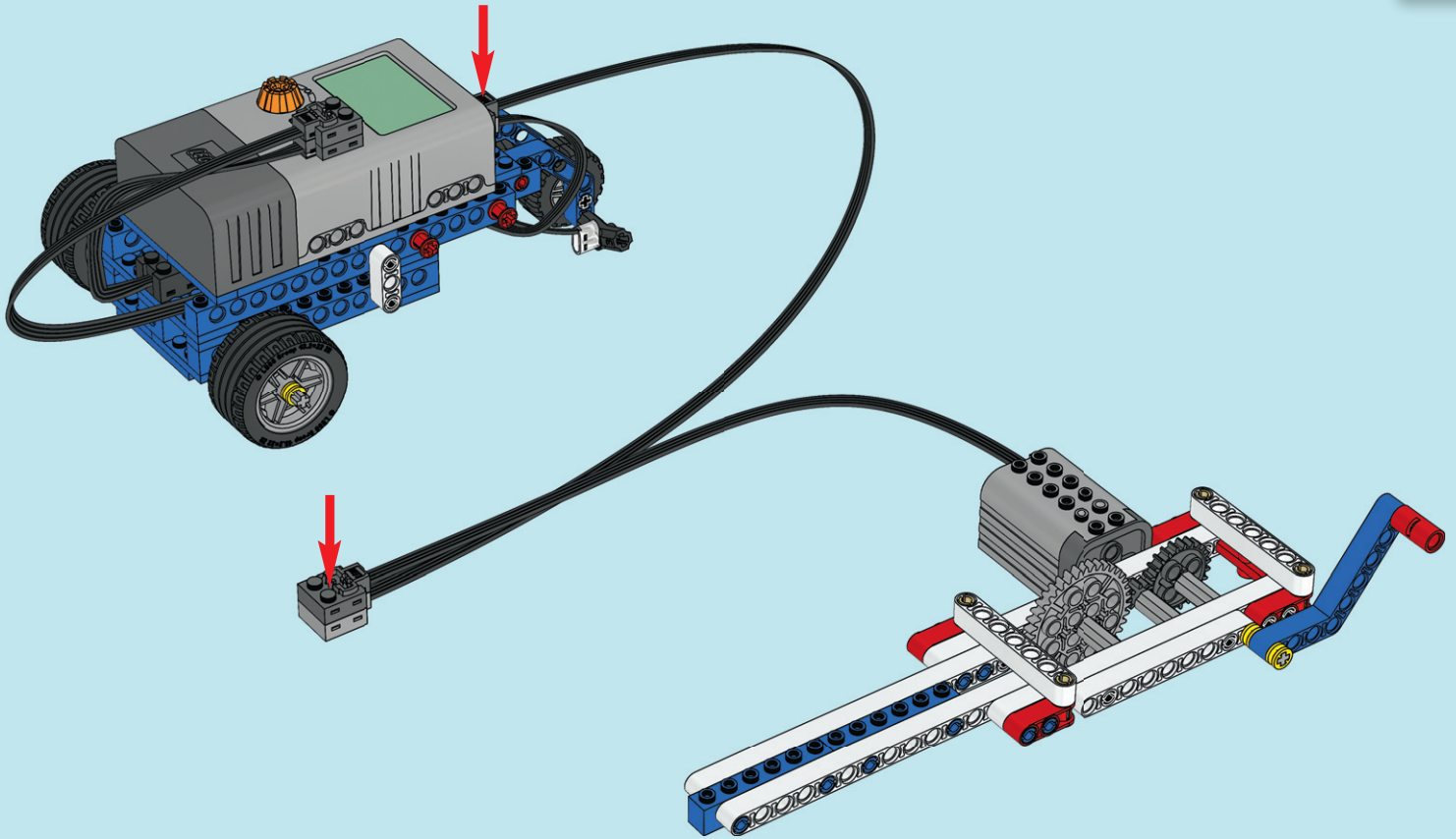

1

